



A1 x3



A2 x3



A3 x3



A4 x2



A5 x4



A6 x4

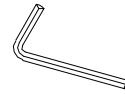

A7 x1

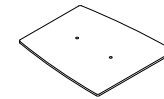

B1 x1

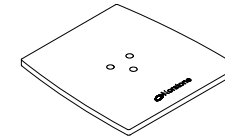

B2 x1



B3 x1

1

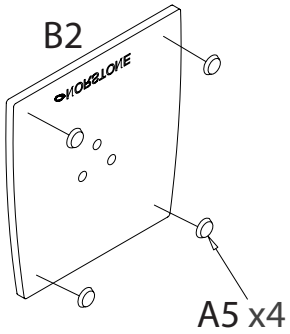

2

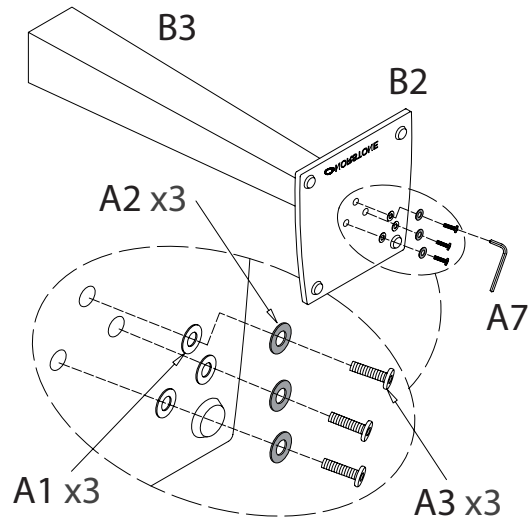

3

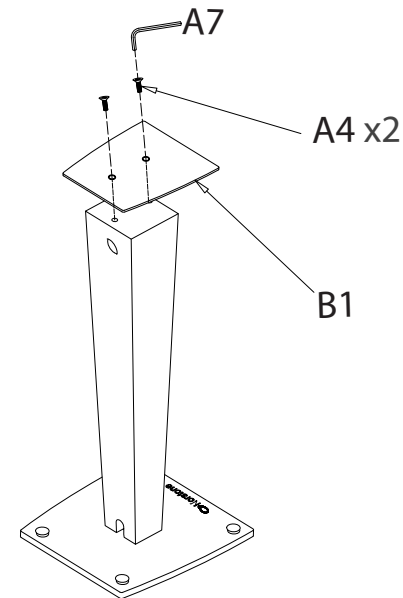

4

