

Panasonic®

Model No.

TH-42BT300U

TH-50BT300U

Operating Instructions

High Definition Plasma Display



English

Before connecting, operating or adjusting this product,
please read these instructions completely.
Please keep this manual for future reference.

HDMI

	CAUTION RISK OF ELECTRIC SHOCK DO NOT OPEN	
WARNING: To reduce the risk of electric shock, do not remove cover or back. No user-serviceable parts inside. Refer servicing to qualified service personnel.		



The lightning flash with arrow-head within a triangle is intended to tell the user that parts inside the product are a risk of electric shock to persons.



The exclamation point within a triangle is intended to tell the user that important operating and servicing instructions are in the papers with the appliance.

WARNING : To prevent damage which may result in fire or shock hazard, do not expose this apparatus to rain or moisture.
Do not place containers with water (flower vase, cups, cosmetics, etc.) above the set.
(including on shelves above, etc.)

WARNING : 1) To prevent electric shock, do not remove cover. No user serviceable parts inside. Refer servicing to qualified service personnel.
2) Do not remove the grounding pin on the power plug. This apparatus is equipped with a three pin grounding-type power plug. This plug will only fit a grounding-type power outlet. This is a safety feature. If you are unable to insert the plug into the outlet, contact an electrician.
Do not defeat the purpose of the grounding plug.



As an ENERGY STAR® Partner, Panasonic has determined that this product meets the ENERGY STAR® guidelines for energy efficiency.

Important Safety Instructions

- 1) Read these instructions.
- 2) Keep these instructions.
- 3) Heed all warnings.
- 4) Follow all instructions.
- 5) Do not use this apparatus near water.
- 6) Clean only with dry cloth.
- 7) Do not block any ventilation openings. Install in accordance with the manufacturer's instructions.
- 8) Do not install near any heat sources such as radiators, heat registers, stoves, or other apparatus (including amplifiers) that produce heat.
- 9) Do not defeat the safety purpose of the polarized or grounding-type plug. A polarized plug has two blades with one wider than the other. A grounding type plug has two blades and a third grounding prong. The wide blade or the third prong are provided for your safety. If the provided plug does not fit into your outlet, consult an electrician for replacement of the obsolete outlet.
- 10) Protect the power cord from being walked on or pinched particularly at plugs, convenience receptacles, and the point where they exit from the apparatus.
- 11) Only use attachments / accessories specified by the manufacturer.
- 12) Use only with the cart, stand, tripod, bracket, or table specified by the manufacturer, or sold with the apparatus. When a cart is used, use caution when moving the cart / apparatus combination to avoid injury from tip-over.
- 13) Unplug this apparatus during lightning storms or when unused for long periods of time.
- 14) Refer all servicing to qualified service personnel. Servicing is required when the apparatus has been damaged in any way, such as power-supply cord or plug is damaged, liquid has been spilled or objects have fallen into the apparatus, the apparatus has been exposed to rain or moisture, does not operate normally, or has been dropped.
- 15) To prevent electric shock, ensure the grounding pin on the AC cord power plug is securely connected.



Dear Panasonic Customer

Welcome to the Panasonic family of customers. We hope that you will have many years of enjoyment from your new Plasma Display.

To obtain maximum benefit from your set, please read these Instructions before making any adjustments, and retain them for future reference.

Retain your purchase receipt as well, and record the model number and serial number of your set in the space provided on the rear cover of these instructions.

Visit our Panasonic Web Site <http://panasonic.net>

Table of Contents

Important Safety Instructions	3	POWER SAVE.....	42
FCC STATEMENT	5	STANDBY SAVE	42
Safety Precautions	6	PC POWER MANAGEMENT	42
Maintenance	7	DVI-D POWER MANAGEMENT	42
3D Safety Precautions.....	8	NO SIGNAL POWER OFF	42
Accessories	10	NO ACTIVITY POWER OFF	42
Accessories Supplied	10	OSD DESIGN.....	43
Remote Control Batteries	10	OSD POSITION	43
Connections	11	OSD LANGUAGE.....	43
Speaker connection.....	11	3D SETTINGS.....	44
AC cord connection and fixing, cable fixing.....	11	SIGNAL menu	45
Video equipment connection	12	WAVEFORM MONITOR.....	47
VIDEO and COMPONENT / RGB IN connection...	12	MARKER SETTINGS	48
HDMI connection.....	13	RGB/MONO SETTINGS	50
DVI-D IN connection.....	13	SCREENSAVER.....	51
PC Input Terminals connection.....	14	EXTENDED LIFE SETTINGS	53
SERIAL Terminals connection	15	Customizing the Input labels	56
Power ON / OFF	16	FUNCTION BUTTON SETTINGS	56
Selecting the input signal	18	DAY/TIME SETUP / ON/OFF TIMER SETUP	57
Basic Controls	19	Network Setup.....	58
ASPECT Controls	21	OPTIONS Adjustments	59
Digital Zoom	22	3D Safety Precautions (To hide 3D Safety Precautions) ...	61
Viewing 3D images	23	Audio input select	62
To view the 3D images	23	Using FUNCTION button	63
Troubleshooting for 3D Eyewear	24	Using Network Function	65
Table of images that can be seen for each 3D		Example of Network Connection	65
Picture Format and the source image format	24	Command Control	65
On-Screen Menu Displays	25	PJLink™ Protocol.....	66
Adjusting POS. /SIZE	26	Using Web Browser Control	67
PICTURE Adjustments	29	Before Using Web Browser Control.....	67
ADVANCED SETTINGS.....	31	Access from Web Browser	67
Color space adjustment (COLOR GAMUT)	33	Display Control (BASIC CONTROL/OPTION	
Picture Profiles	35	CONTROL Screen)	68
Saving profiles	36	NETWORK SETTING (Network Setup Screen)	69
Loading profiles	37	Password Setting (Password Setup Screen)	69
Editing profiles	38	Troubleshooting	70
SOUND Adjustment	39	List of Aspect Modes	71
SDI SOUND OUTPUT.....	39	Applicable Input Signals	72
SETUP menu	40	ID Remote Control Function	73
COMPONENT / RGB IN SELECT.....	40	Shipping condition	74
YUV / RGB IN SELECT.....	40	Specifications	75
EXTERNAL SCALER MODE	41		

FCC STATEMENT

This equipment has been tested and found to comply with the limits for a Class B digital device, pursuant to Part 15 of the FCC Rules. These limits are designed to provide reasonable protection against harmful interference in a residential installation. This equipment generates, uses and can radiate radio frequency energy and, if not installed and used in accordance with the instructions, may cause harmful interference to radio communications. However, there is no guarantee that interference will not occur in a particular installation. If this equipment does cause harmful interference to radio or television reception, which can be determined by turning the equipment off and on, the user is encouraged to try to correct the interference by one or more of the following measures:

- Reorient or relocate the receiving antenna.
- Increase the separation between the equipment and receiver.
- Connect the equipment into an outlet on a circuit different from that to which the receiver is connected.
- Consult the dealer or an experienced technician for help.

This device complies with Part 15 of the FCC Rules. Operation is subject to the following two conditions: (1) This device may not cause harmful interference, and (2) this device must accept any interference received, including interference that may cause undesired operation.

FCC CAUTION:

To assure continued compliance, follow the attached installation instructions and use only shielded interface cables when connecting to computer or peripheral devices. Any changes or modifications not expressly approved by Panasonic Corp. of North America could void the user's authority to operate this device.

FCC Declaration of Conformity

Model No. TH-42BT300U, TH-50BT300U

Responsible Party: Panasonic Corporation of North America
Three Panasonic Way 2F-5, Secaucus, NJ 07094
Contact Source: Panasonic Solutions Company
Panasonic Plasma Concierge 1-800-973-4390

CANADIAN NOTICE:

This Class B digital apparatus complies with Canadian ICES-003.

Note:

Do not allow a still picture to be displayed for an extended period, as this can cause a permanent image retention to remain on the Plasma Display.

Examples of still pictures include logos, video games, computer images, teletext and images displayed in 4:3 mode.

Trademark Credits

- VGA is a trademark of International Business Machines Corporation.
- Macintosh is a registered trademark of Apple Inc., USA.
- SVGA, XGA, SXGA and UXGA are registered trademarks of the Video Electronics Standard Association.
Even if no special notation has been made of company or product trademarks, these trademarks have been fully respected.
- HDMI, the HDMI Logo, and High-Definition Multimedia Interface are trademarks or registered trademarks of HDMI Licensing LLC in the United States and other countries.

Safety Precautions

CAUTION

This Plasma Display is for use only with the following optional accessories. Use with any other type of optional accessories may cause instability which could result in the possibility of injury.

(All of the following accessories are manufactured by Panasonic Corporation.)

- Speakers TY-SP42P8W-K (for TH-42BT300U)
TY-SP50P8W-K (for TH-50BT300U)
- Pedestal TY-ST20-K
- Mobile stand TY-ST58PF20
- Wall-hanging bracket (vertical) TY-WK42PV20
- Wall-hanging bracket (angled) TY-WK42PR20
- Ceiling-hanging bracket TY-CE42PS20
- BNC Dual Video Terminal Board TY-FB9BD
- HD-SDI Terminal Board TY-FB9HD
- HD-SDI Terminal Board with audio TY-FB10HD
- Dual Link HD-SDI Terminal Board TY-FB11DHD
- Dual HD-SDI Terminal Board for 3D TY-FB30DHD3D
- Dual HDMI Terminal Board TY-FB10HMD
- DVI-D Terminal Board TY-FB11DD
- Dual DVI-D Terminal Board for 3D TY-FB30DD3D
- AV Terminal Box TY-TB10AV
- 3D IR TRANSMITTER TY-3D30TRW

Always be sure to ask a qualified technician to carry out set-up.

Small parts can present choking hazard if accidentally swallowed. Keep small parts away from young children. Discard unneeded small parts and other objects, including packaging materials and plastic bags/sheets to prevent them from being played with by young children, creating the potential risk of suffocation.

■ When using the Plasma Display

Do not bring your hands, face or objects close to the ventilation holes of the Plasma Display.

- Top of the Plasma Display is usually very hot due to the high temperature of exhaust air being released through the ventilation holes. Burns or personal injuries can happen if any body parts are brought too close. Placing any object near the top of the display could also result in heat damages to the object as well as to the Display if its ventilation holes are blocked.

Be sure to disconnect all cables before moving the Plasma Display.

- Moving the Display with its cables attached might damage the cables which, in turn, can cause fire or electric shock.

Disconnect the power plug from the wall outlet as a safety precaution before carrying out any cleaning.

- Electric shocks can result if this is not done.

Clean the power cable regularly to prevent it from becoming dusty.

- Built-up dust on the power cord plug can increase humidity which might damage the insulation and cause fire. Unplug the cord from the wall outlet and clean it with a dry cloth.

This Plasma Display radiates infrared rays, therefore it may affect other infrared communication equipment. Install your infrared sensor in a place away from direct or reflected light from your Plasma Display.

Note:

Do not allow a still picture to be displayed for an extended period, as this can cause a permanent image retention to remain on the Plasma Display.

Examples of still pictures include logos, video games, computer images, teletext and images displayed in 4:3 mode.

WARNING

■ Setup

Do not place the Plasma Display on sloped or unstable surfaces, and ensure that the Plasma Display does not hang over the edge of the base.

- The Plasma Display may fall off or tip over.

Do not place any objects on top of the Plasma Display.

- If water spills onto the Plasma Display or foreign objects get inside it, a short-circuit may occur which could result in fire or electric shock. If any foreign objects get inside the Plasma Display, please consult an Authorized Service Center.

Do not cover the ventilation holes.

- Doing so may cause the Plasma Display to overheat, which can cause fire or damage to the Plasma Display.

Transport only in upright position!

- Transporting the unit with its display panel facing upright or downward may cause damage to the internal circuitry.

If using the pedestal (optional accessory), leave a space of 3 15/16" (10 cm) or more at the top, left and right, and 2 3/4" (7 cm) or more at the rear, and also keep the space between the bottom of the display and the floor surface. If using some other setting-up method, follow the manual of it. (If there is no specific indication of installation dimension in the installation manual, leave a space of 3 15/16" (10 cm) or more at the top, bottom, left and right, and 2 3/4" (7 cm) or more at the rear.)

An apparatus with CLASS I construction shall be connected to a mains socket outlet with a protective earthing connection.

■ AC Power Supply Cord

The Plasma Display is designed to operate on 110 - 127 V AC, 50/60 Hz.

Ensure that the mains plug is easily accessible.

Do not use any power supply cord other than that provided with this unit.

- Doing so may cause fire or electric shocks.

Securely insert the power cord plug as far as it will go.

- If the plug is not fully inserted, heat may be generated which could cause fire. If the plug is damaged or the wall socket plate is loose, they should not be used.

Do not handle the power cord plug with wet hands.

- Doing so may cause electric shocks.

Do not do anything that might damage the power cable. When disconnecting the power cable, hold the plug, not the cable.

- Do not make any modifications, place heavy objects on, place near hot objects, heat, bend, twist or forcefully pull the power cable. Doing so may cause damage to the power cable which can cause fire or electric shock. If damage to the cable is suspected, have it repaired at an Authorized Service Center.

If the Plasma Display will not be used for a long period of time, unplug the power cord from the wall outlet.

■ If problems occur during use

If a problem occurs (such as no picture or no sound), or if smoke or an abnormal odor is detected from the Plasma Display, unplug the power cord immediately.

- Continuous use of the Display under these conditions might cause fire or permanent damage to the unit. Have the Display evaluated at an Authorized Service Center. Services to the Display by any unauthorized personnel are strongly discouraged due to its high voltage dangerous nature.

If water or foreign objects get inside the Plasma Display, if the Plasma Display is dropped, or if the cabinet becomes damaged, disconnect the power cord plug immediately.

- A short may occur, which could cause fire. Contact an Authorized Service Center for any repairs that need to be made.

Maintenance

The front of the display panel has been specially treated. Wipe the panel surface gently using only a cleaning cloth or a soft, lint-free cloth.

- If the surface is particularly dirty, wipe with a soft, lint-free cloth which has been soaked in pure water or water in which neutral detergent has been diluted 100 times, and then wipe it evenly with a dry cloth of the same type until the surface is dry.
- Do not scratch or hit the surface of the panel with fingernails or other hard objects, otherwise the surface may become damaged. Furthermore, avoid contact with volatile substances such as insect sprays, solvents and thinner, otherwise the quality of the surface may be adversely affected.

If the cabinet becomes dirty, wipe it with a soft, dry cloth.

- If the cabinet is particularly dirty, soak the cloth in water to which a small amount of neutral detergent has been added and then wring the cloth dry. Use this cloth to wipe the cabinet, and then wipe it dry with a dry cloth.
- Do not allow any detergent to come into direct contact with the surface of the Plasma Display. If water droplets get inside the unit, operating problems may result.
- Avoid contact with volatile substances such as insect sprays, solvents and thinner, otherwise the quality of the cabinet surface may be adversely affected or the coating may peel off. Furthermore, do not leave it for long periods in contact with articles made from rubber or PVC.

Safety Precautions

3D Safety Precautions

WARNING

■ Small Parts

3D Eyewear contains small parts (battery and specialised band, etc.) and must be kept out of reach of small children to avoid accidental ingestion.

■ Disassembly

Do not disassemble or modify the 3D Eyewear.

■ Lithium Battery

Batteries must not be exposed to excessive heat such as sunshine, fire or the like.



CAUTION

To enjoy 3D images safely and comfortably, please read these instructions fully.

■ Use for commercial applications and public viewing

Someone in authority should responsibly convey the precautions for use of the 3D Eyewear to the user.

■ 3D Eyewear

Do not drop, exert pressure on, or step on the 3D Eyewear.

Always store the 3D Eyewear in the case provided when not in use.

Be careful of the tips of the frame when putting on the 3D Eyewear.

Be careful not to trap a finger in the hinge section of the 3D Eyewear.

Pay special attention when children are using the 3D Eyewear.

3D Eyewear should not be used by children younger than 5 - 6 years old, as a guideline.

All children must be fully supervised by parents or guardians who must ensure their safety and health throughout the using 3D Eyewear.

■ Viewing 3D Content

Content for 3D viewing includes commercially available Blu-ray discs, 3D broadcasts, etc. When preparing your own 3D content, ensure that it is properly produced.

Do not use the 3D Eyewear if you have a history of over-sensitivity to light, heart problems, or have any other existing medical conditions.

Please stop using the 3D Eyewear immediately, if you feel tired, are not feeling well or experience any other uncomfortable sensation.

Take an appropriate break after viewing a 3D movie.

Take a break of between 30 - 60 minutes after viewing 3D content on interactive devices such as 3D games or computers.

Be careful not to strike the screen or other people unintentionally. When using the 3D Eyewear the distance between the user and screen can be misjudged.

The 3D Eyewear must only be worn when viewing 3D content.

If you do not look toward the screen for a while when viewing 3D images, the 3D Eyewear may be turned off automatically.

If you suffer from any eyesight problems (short / far-sighted, astigmatism, eyesight differences in left and right), please ensure to correct your vision before using the 3D Eyewear.

Stop using the 3D Eyewear if you can clearly see double images when viewing 3D content.

Do not use the 3D Eyewear at a distance less than the recommended distance.

View from at least the recommended distance (3 times the effective height of the screen).

Recommended distance

TH-42BT300U: 63.0"/1.6 m

TH-50BT300U: 74.9"/1.9 m

When the top and bottom area of the screen is blackened, such as movies, view the screen at a distance 3 times further than the height of the actual image. (That makes the distance closer than above recommended figure.)

■ 3D Eyewear Use

Before using the 3D Eyewear, ensure no breakable objects surrounding the user to avoid any accidental damage or injury.

Remove the 3D Eyewear before moving around to avoid falling or accidental injury.

Always put the 3D Eyewear in the case (supplied) after use.

Use the 3D Eyewear only for the intended purpose and nothing else.

Do not use 3D Eyewear in the condition of high temperature.

Do not use if the 3D Eyewear is physically damaged.

Do not use any devices that emit the infrared signals near the 3D Eyewear, as this may cause the 3D Eyewear false operations.

Do not use devices (such as mobile phones or personal transceivers) that emit strong electromagnetic waves near the 3D Eyewear as this may cause the 3D Eyewear to malfunction.

Stop using the 3D Eyewear immediately if a malfunction or fault occurs.

Stop using the 3D Eyewear immediately if you experience any redness, pain, or skin irritation around the nose or temples.

In rare cases, the materials used in the 3D Eyewear may cause an allergic reaction.

■ Lithium Battery

Danger of explosion if battery is incorrectly replaced. Replace only with the same or equivalent type.

Accessories

Accessories Supplied

Check that you have the Accessories and items shown

Operating Instruction book

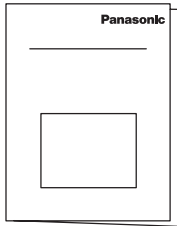

CD-ROM (Operating instructions)

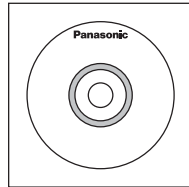

Remote Control Transmitter N2QAYB000689



Batteries for the Remote Control Transmitter (AA Size × 2)

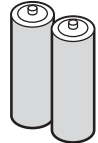

Clamper × 1 TMME289

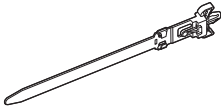

AC cord

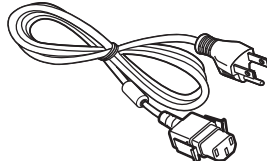

Ferrite core × 2 J0KG00000014

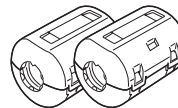

Use the Ferrite cores to comply with the EMC standard. (see page 65)

Remote Control Batteries

Requires two AA batteries.

1. Pull and hold the hook, then open the battery cover.

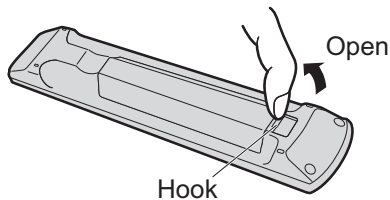

2. Insert batteries - note correct polarity (+ and -).

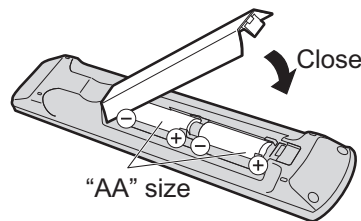

Helpful Hint:

For frequent remote control users, replace old batteries with Alkaline batteries for longer life.

⚠️ Precaution on battery use

Incorrect installation can cause battery leakage and corrosion that will damage the remote control transmitter. Disposal of batteries should be in an environment-friendly manner.

Observe the following precautions:

1. Batteries should always be replaced as a pair. Always use new batteries when replacing the old set.
2. Do not combine a used battery with a new one.
3. Do not mix battery types (example: "Zinc Carbon" with "Alkaline").
4. Do not attempt to charge, short-circuit, disassemble, heat or burn used batteries.
5. Battery replacement is necessary when the remote control acts sporadically or stops operating the Plasma Display.
6. Do not burn or breakup batteries.

Batteries must not be exposed to excessive heat such as sunshine, fire or the like.

Connections

Speaker connection

When connecting the speakers, be sure to use only the optional accessory speakers. Refer to the speaker's Installation Manual for details on speaker installation.

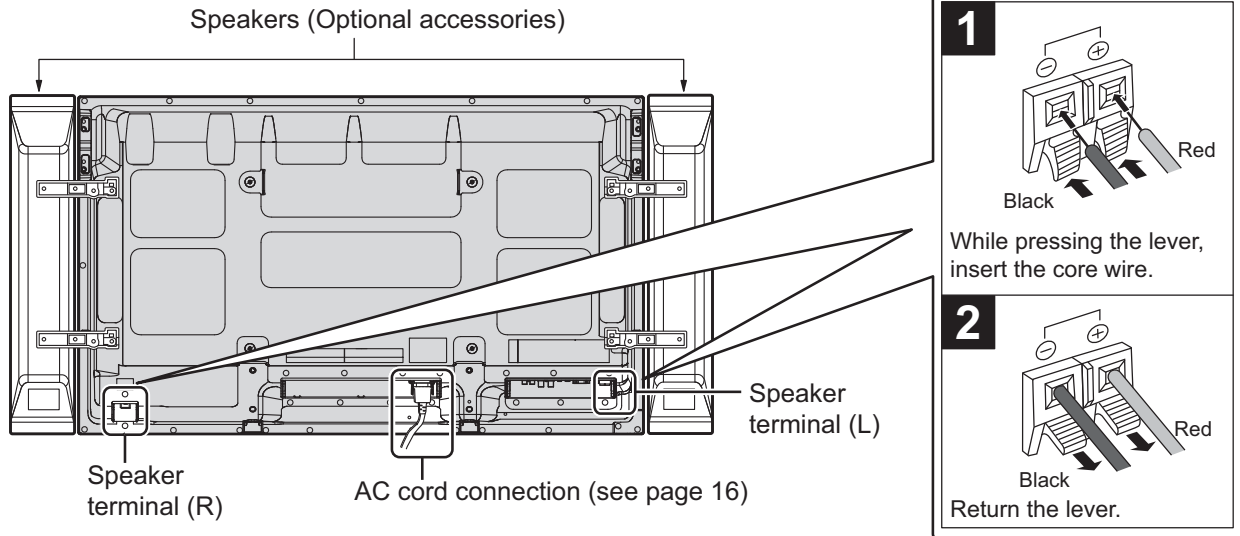

AC cord connection and fixing, cable fixing

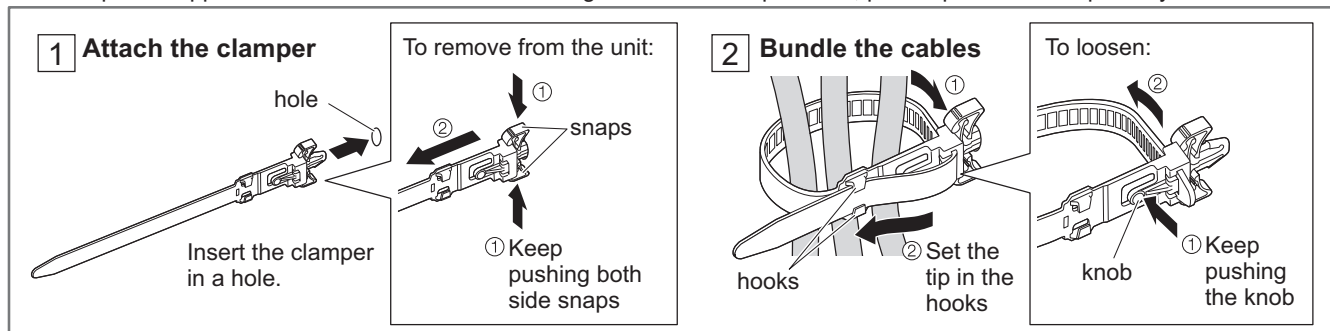
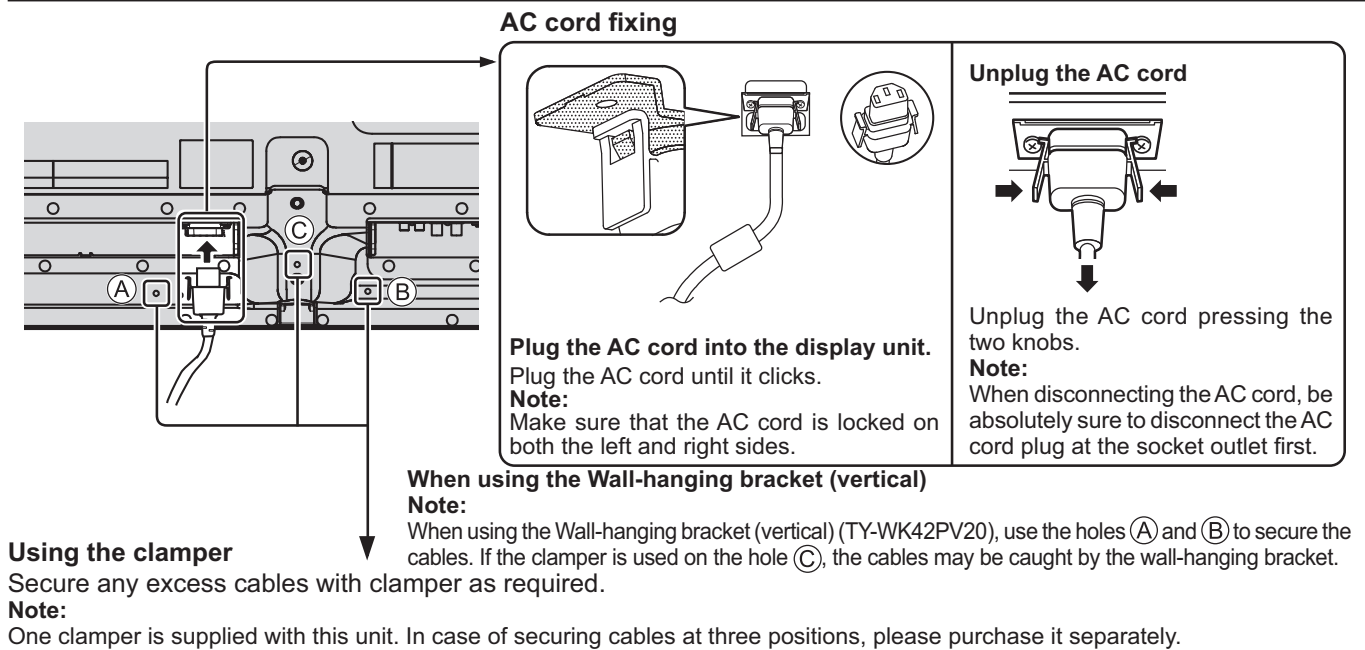

Connections

Video equipment connection

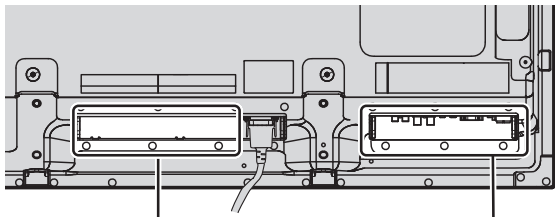

SLOT: Terminal board (optional accessories) insert slot (see page 6)

Note:
The right side slot is for factory use only. The terminal board with 1-slot width does not function when installed in the right side slot.

3D IR TRANSMITTER:
Connect the 3D IR TRANSMITTER (optional accessory).

SERIAL:
Control the Plasma Display by connecting to PC. (see page 15)

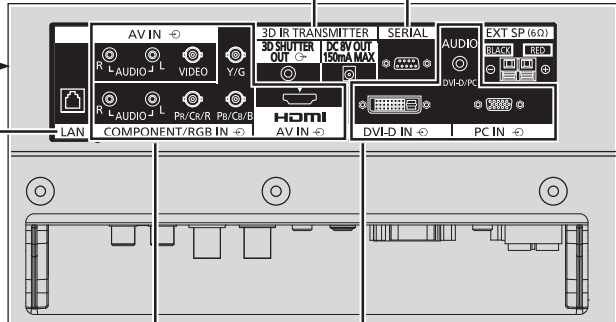

Terminals are on the bottom side of the Plasma Display.

LAN: Connect to a network to control the unit. (see page 65)

AV IN (VIDEO): Composite Video Input Terminal (see below)
COMPONENT/RGB IN: Component/RGB Video Input Terminal (see below)
AV IN (HDMI): HDMI Input Terminal (see page 13)
 Connect to video equipment such as VCR or DVD player.

DVI-D IN: DVI-D Input Terminal (see page 13)
PC IN: PC Input Terminal
 Connect to video terminal of PC or equipment with Y, P_B(C_B) and P_R(C_R) output. (see page 14)

VIDEO and COMPONENT / RGB IN connection

Note:

Additional equipment, cables and adapter plugs shown are not supplied with this set.

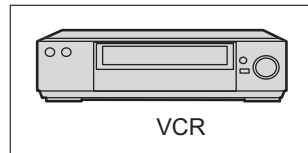
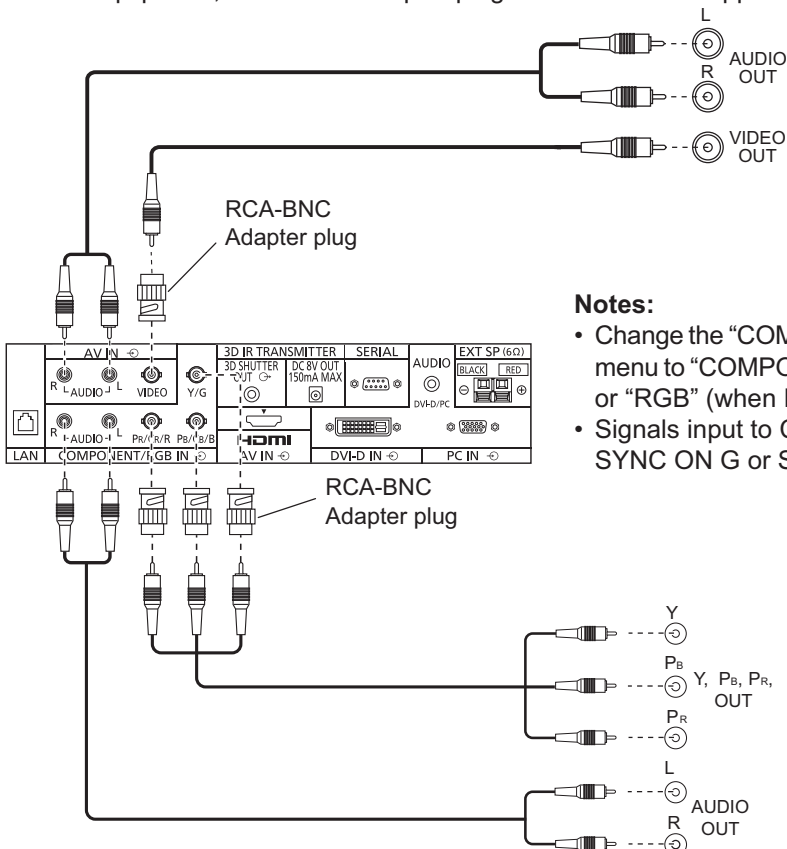

Notes:

- Change the "COMPONENT/RGB-IN select" setting in the "SETUP" menu to "COMPONENT" (when COMPONENT signal connection) or "RGB" (when RGB signal connection). (see page 40)
- Signals input to COMPONENT/RGB IN terminals correspond to SYNC ON G or SYNC ON Y.

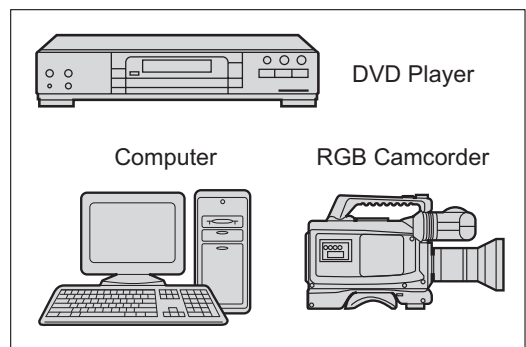

HDMI connection

[Pin assignments and signal names]

Pin No.	Signal Name	Pin No.	Signal Name
①	T.M.D.S Data2+	⑪	T.M.D.S Clock Shield
②	T.M.D.S Data2 Shield	⑫	T.M.D.S Clock-
③	T.M.D.S Data2-	⑬	CEC
④	T.M.D.S Data1+	⑭	Reserved (N.C. on device)
⑤	T.M.D.S Data1 Shield		
⑥	T.M.D.S Data1-	⑮	SCL
⑦	T.M.D.S Data0+	⑯	SDA
⑧	T.M.D.S Data0 Shield	⑰	DDC/CEC Ground
⑨	T.M.D.S Data0-	⑱	+5V Power
⑩	T.M.D.S Clock+	⑲	Hot Plug Detect

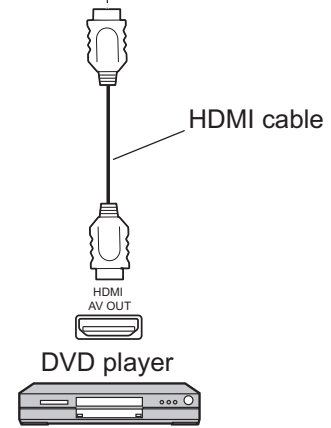
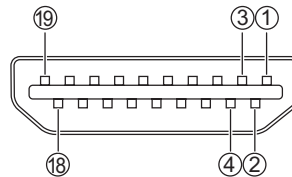
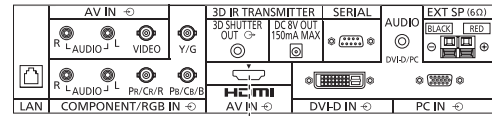

Note:

Additional equipment and HDMI cable shown are not supplied with this set.

DVI-D IN connection

PC with DVI-D video out

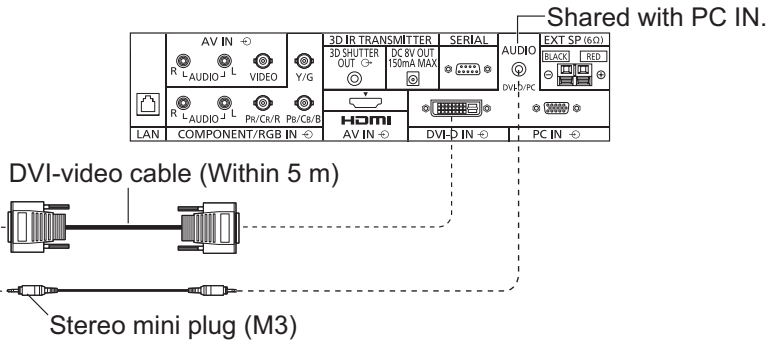

DVI-D Input Connector Pin Layouts

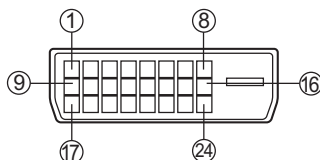

Connection port view

Pin No.	Signal Name	Pin No.	Signal Name
①	T.M.D.S. data 2-	⑬	
②	T.M.D.S. data 2+	⑭	+5 V DC
③	T.M.D.S. data 2 shield	⑮	Ground
④		⑯	Hot plug detect
⑤		⑰	T.M.D.S. data 0-
⑥	DDC clock	⑱	T.M.D.S. data 0+
⑦	DDC data	⑲	T.M.D.S. data 0 shield
⑧		⑳	
⑨	T.M.D.S. data 1-	㉑	
⑩	T.M.D.S. data 1+	㉒	T.M.D.S. clock shield
⑪	T.M.D.S. data 1 shield	㉓	T.M.D.S. clock+
⑫		㉔	T.M.D.S. clock-

Notes:

- Additional equipment and cables shown are not supplied with this set.
- Use the DVI-D cable complying with the DVI standard. Image deterioration may occur depending on the length or the quality of the cable.

Connections

PC Input Terminals connection

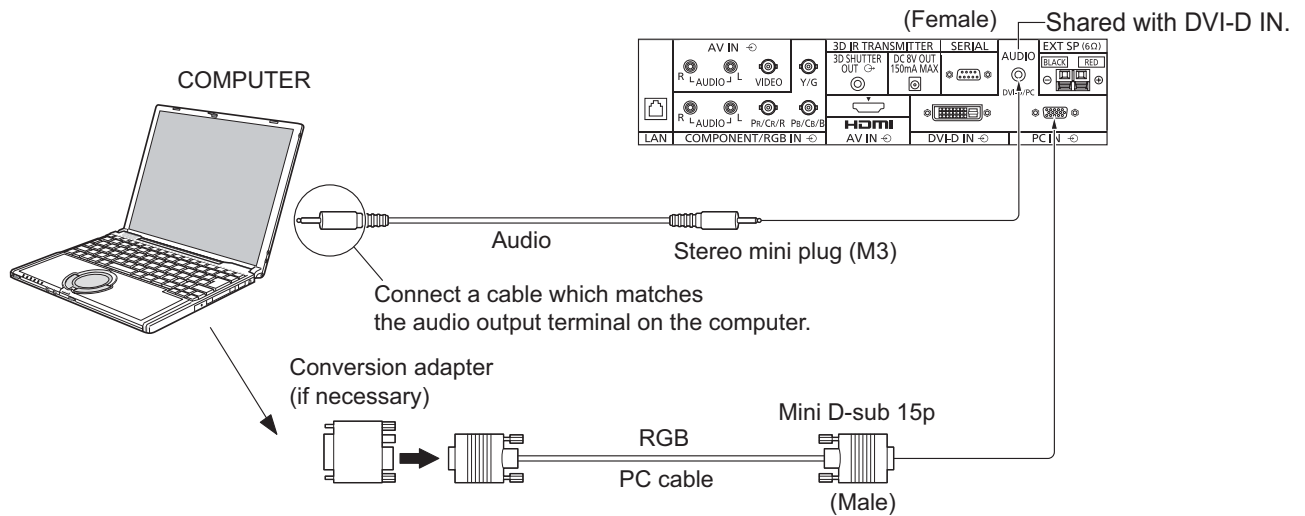

Notes:

- With regard to the typical PC input signals that are described in the applicable input signals list (see page 72), adjustment values such as for the standard picture positions and sizes have already been stored in this unit. You can add up to eight PC input signal types that are not included in the list.
- Computer signals which can be input are those with a horizontal scanning frequency of 15 to 110 kHz and vertical scanning frequency of 48 to 120 Hz. (However, the image will not be displayed properly if the signals exceed 1,200 lines.)
- The display resolution is a maximum of 1,440 × 1,080 dots when the aspect mode is set to “4:3”, and 1,920 × 1,080 dots when the aspect mode is set to “FULL”. If the display resolution exceeds these maximums, it may not be possible to show fine detail with sufficient clarity.
- The PC input terminals are DDC2B-compatible. If the computer being connected is not DDC2B-compatible, you will need to make setting changes to the computer at the time of connection.
- Some PC models cannot be connected to the set.
- There is no need to use an adapter for computers with DOS/V compatible Mini D-sub 15P terminal.
- The computer shown in the illustration is for example purposes only.
- Additional equipment and cables shown are not supplied with this set.
- Do not set the horizontal and vertical scanning frequencies for PC signals which are above or below the specified frequency range.
- Component Input is possible with the pin 1, 2, 3 of the Mini D-sub 15P Connector.
- Change the “COMPONENT/RGB-IN SELECT” setting in the “SETUP” menu to “COMPONENT” (when COMPONENT signal connection) or “RGB” (when RGB signal connection). (see page 40)

Signal Names for Mini D-sub 15P Connector

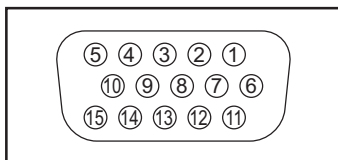

Pin Layout for PC Input Terminal

Pin No.	Signal Name	Pin No.	Signal Name	Pin No.	Signal Name
①	R (P _R /C _R)	⑥	GND (Ground)	⑪	NC (not connected)
②	G (Y)	⑦	GND (Ground)	⑫	SDA
③	B (P _B /C _B)	⑧	GND (Ground)	⑬	HD/SYNC
④	NC (not connected)	⑨	+5 V DC	⑭	VD
⑤	GND (Ground)	⑩	GND (Ground)	⑮	SCL

SERIAL Terminals connection

The SERIAL terminal is used when the Plasma Display is controlled by a computer.

Note: To use serial control for this unit, make sure to set the "CONTROL I/F SELECT" in the "NETWORK SETUP" menu to "RS-232C". (see page 58)

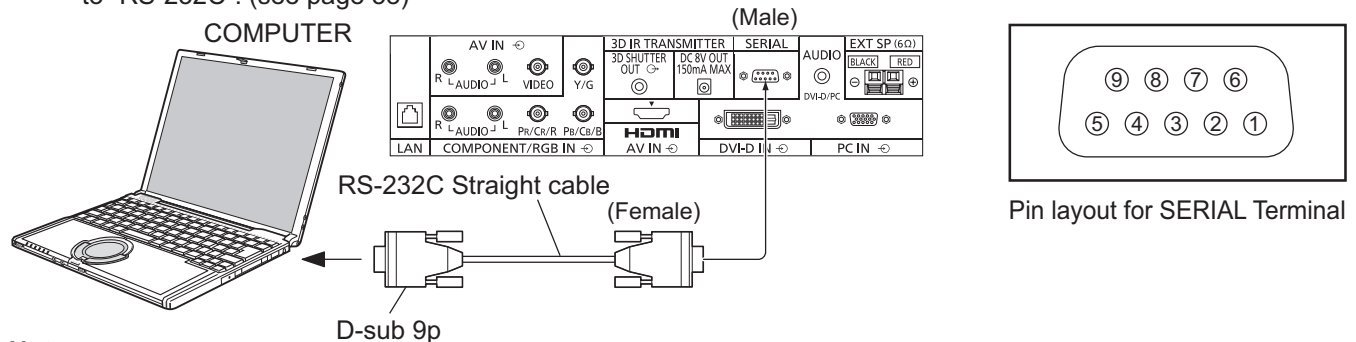

Notes:

- Use the RS-232C straight cable to connect the computer to the Plasma Display.
- The computer shown is for example purposes only.
- Additional equipment and cables shown are not supplied with this set.

The SERIAL terminal conforms to the RS-232C interface specification, so that the Plasma Display can be controlled by a computer which is connected to this terminal.

The computer will require software which allows the sending and receiving of control data which satisfies the conditions given below. Use a computer application such as programming language software. Refer to the documentation for the computer application for details.

Communication parameters

Signal level	RS-232C compliant
Synchronization method	Asynchronous
Baud rate	9600 bps
Parity	None
Character length	8 bits
Stop bit	1 bit
Flow control	-

Basic format for control data

The transmission of control data from the computer starts with a STX signal, followed by the command, the parameters, and lastly an ETX signal in that order. If there are no parameters, then the parameter signal does not need to be sent.

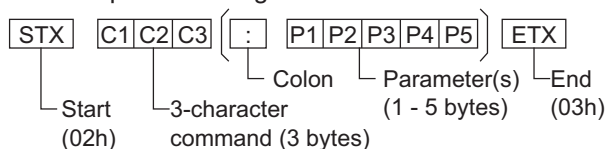

Notes:

- If multiple commands are transmitted, be sure to wait for the response for the first command to come from this unit before sending the next command.
- If an incorrect command is sent by mistake, this unit will send an "ER401" command back to the computer.
- S1A and S1B of Command IMS are available only when a dual input terminal board is attached.
- Consult your local Panasonic dealer for detail instructions on command usage.

Signal names for D-sub 9P connector

Pin No.	Details
②	R X D
③	T X D
⑤	GND
④ • ⑥	Non use
⑦ ⑧	(Shorted in this set)
① • ⑨	NC

These signal names are those of computer specifications.

Command

Command	Parameter	Control details
PON	None	Power ON
POF	None	Power OFF
AVL	**	Volume 00 - 63
AMT	0	Audio MUTE OFF
	1	Audio MUTE ON
IMS	None	Input select (toggle)
	SL1	SLOT input (SLOT INPUT)
	S1A	SLOT input (SLOT INPUT A)
	S1B	SLOT input (SLOT INPUT B)
	VD1	VIDEO input (VIDEO)
	YP1	COMPONENT/RGB IN input (COMPONENT)
	HM1 DV1 PC1	HDMI input (HDMI) DVI-D IN input (DVI) PC IN input (PC)
DAM	None	Screen mode select (toggle)
	ZOOM	ZOOM (For Video/SD/PC signal)
	FULL	FULL
	JUST	JUST (For Video/SD signal)
	NORM	4:3 (For Video/SD/PC signal)
	SJST	JUST (For HD signal)
	SNOM	4:3 (For HD signal)
	SFUL	H-FILL (For HD signal)
ZOM2	ZOOM (For HD signal)	

With the power off, this display responds to PON command only.

Power ON / OFF

Connecting the AC cord plug to the Plasma Display.

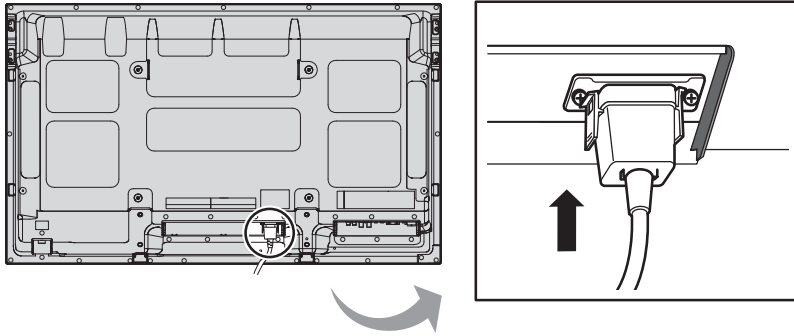

Connecting the plug to the Wall Outlet.

Note:

When disconnecting the AC cord, be absolutely sure to disconnect the AC cord plug at the socket outlet first.

Press the Power switch on the Plasma Display to turn the set on: Power-On.

Power Indicator: Green

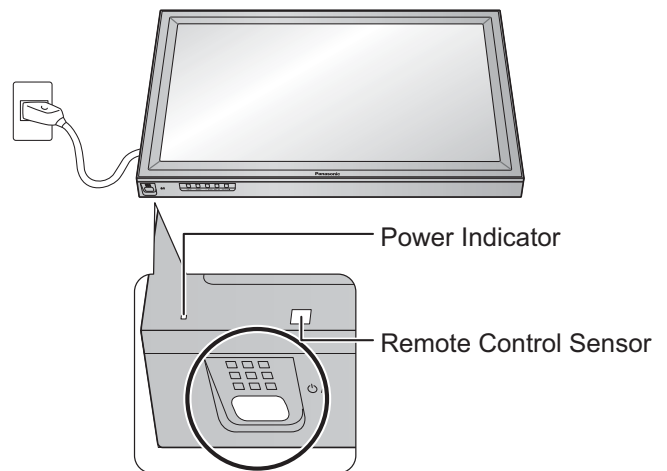

Press the  button on the remote control to turn the Plasma Display off.

Power Indicator: Red (standby)



Press the  button on the remote control to turn the Plasma Display on.

Power Indicator: Green

Turn the power to the Plasma Display off by pressing the /I switch on the unit, when the Plasma Display is on or in standby mode.

Note:

During operation of the power management function, the power indicator turns orange in the power off state.



When first switching on the unit

Following screen will be displayed when the unit is turned on for the first time. Select the items with the remote control. Unit buttons are invalid.

OSD LANGUAGE



DAY/TIME SETUP

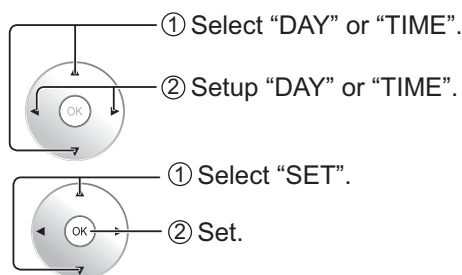
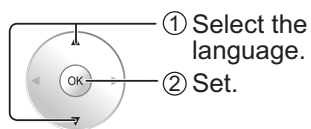
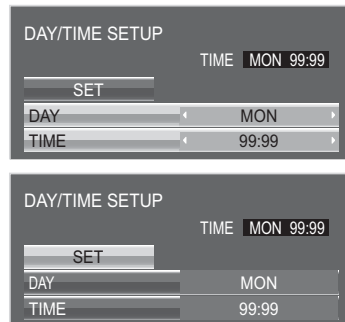

Notes:

- Once the items are set, the screens won't be displayed when switching on the unit next time.
- After the setting, the items can be changed in the following menus.
OSD LANGUAGE (see page 43)
DAY/TIME SETUP (see page 57)

Power ON warning message

The following message may be displayed when turning the unit power ON:

3D Safety Precautions

When 3D images will be viewed by unspecified number of people or used for commercial applications, someone in authority should convey the following precautions. These precautions should be followed in the home as well.

To enjoy 3D images safely and comfortably, please refer to the Operating Instructions for in-depth description. Please refrain from viewing 3D images if you do not feel well or are experiencing visual fatigue.

Activate 3D Safety Precautions if you deliver 3D images to unspecified audiences for business or other purposes. If "3D FUNCTION" in "3D SETTINGS" is set to "ON", a warning message is displayed every time the power is turned ON. (see page 44)

No activity power off Precautions

'NO ACTIVITY POWER OFF' IS ENABLED.

If "NO ACTIVITY POWER OFF" in SETUP menu is set to "ENABLE", a warning message is displayed every time the power is turned ON. (see page 42)

These message displays can be set with the following menu: Options menu

- 3D Safety Precautions (see page 61)
- Power On Message (see page 61)

Selecting the input signal



Press to select the input signal to be played back from the equipment which has been connected to the Plasma Display.

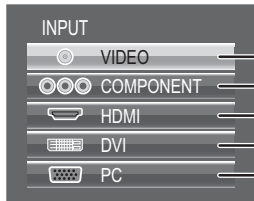

VIDEO input terminal in AV IN (VIDEO).
 COMPONENT or RGB input terminal in COMPONENT/RGB IN.*
 HDMI input terminal in AV IN (HDMI).
 DVI input terminal in DVI-D IN.
 PC input terminal in PC IN.

* "COMPONENT" may be displayed as "RGB" depending on the setting of "COMPONENT/RGB-IN SELECT". (see page 40)



When an optional Terminal Board is installed:

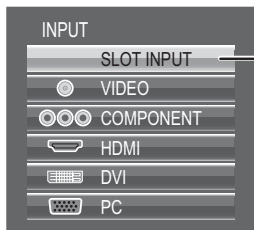

Input terminal in Terminal Board
 When a dual input Terminal Board is installed, "SLOT INPUT A" and "SLOT INPUT B" are displayed.

Using dedicated buttons for input selection



Press to select HDMI signal terminals in HDMI.



Press to select DVI signal terminal in DVI-D IN.



Press to select component or RGB signal terminal in COMPONENT/RGB IN.



Press to select PC signal terminal in PC IN.



Press to select Input terminal in Terminal Board.
 For a dual input terminal board, pressing it allows selection between "SLOT INPUT A" and "SLOT INPUT B".

Notes:

- Selecting is also possible by pressing the INPUT button on the unit.
- Select to match the signals from the source connected to the component/RGB input terminals. (see page 40)
- Image retention (image lag) may occur on the plasma display panel when a still picture is kept on the panel for an extended period. The function that darkens the screen slightly is activated to prevent image retention (see page 70), but this function is not the perfect solution to image retention.

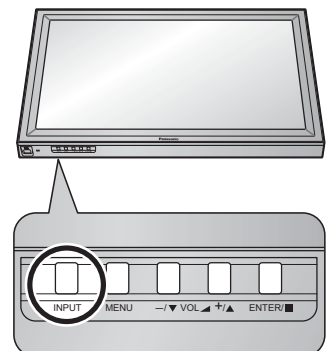

Basic Controls

Main Unit

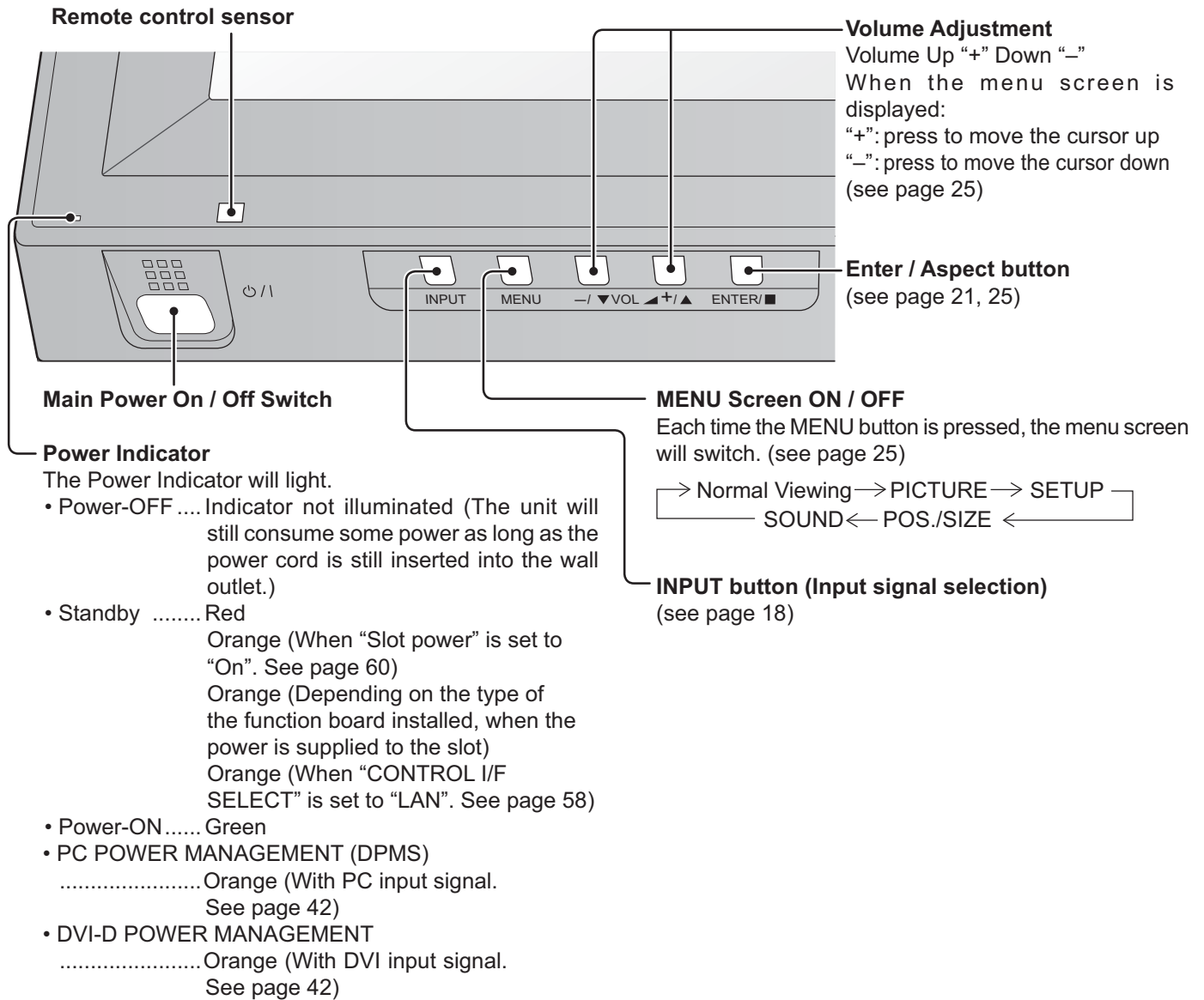

Basic Controls

Remote Control Transmitter

Standby (ON / OFF) button

The Plasma Display must first be plugged into the wall outlet and turned on at the power switch (see page 16). Press this button to turn the Plasma Display On, from Standby mode. Press it again to turn the Plasma Display Off to Standby mode.

LIGHT button

The remote control's buttons illuminate.

AUTO SETUP button

Automatically adjusts the position/ size of the screen. (see page 27)

HDMI button

Press to select HDMI input. (see page 18)

DVI button

Press to select DVI input. (see page 18)

PICTURE button

(see page 29)

RECALL button

Press the "RECALL" button to display the current system status.

- ① Input label
- ② Aspect mode (see page 21)
During 3D images (see page 44)
Audio input (see page 62)
Profile name (see page 37)
NANODRIFT SAVER operating (see page 54)
Mode of RGB/MONO SETTINGS (see page 50)
Mode of HV DELAY (see page 28)
3D COLOR COMPENSATION: OFF (see page 44)
- ③ Off timer
The off timer indicator is displayed only when the off timer has been set.

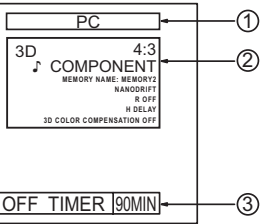

INPUT button

Press to select input signal sequentially. (see page 18)

MEM. LOAD button

(see page 37)

PC button

Press to select PC input. (see page 18)

ASPECT button

Press to adjust the aspect. (see page 21)

SLOT button

Press to select SLOT Terminal Board. (see page 18)

COMPO. button

Press to select Component or RGB input. (see page 18)

MENU button

Displays menu screen. (see page 25)

POS. /SIZE button

(see page 26)

OK button

Press to make selections.

Cursor buttons

RETURN button (see page 25)

Press the RETURN button to return to previous menu screen.

FUNCTION buttons (see page 63)

VIDEO MENU button

Press to select PICTURE MENU. (see page 30)

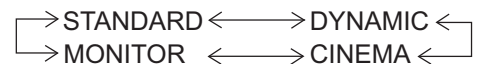

FUNCTION buttons (see page 63)

Numeric buttons (see page 37)

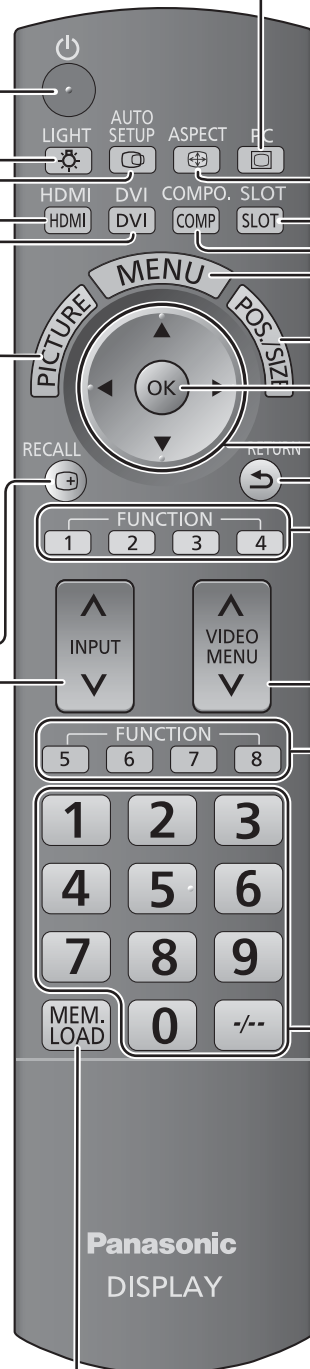

ASPECT Controls

The Plasma Display will allow you to enjoy viewing the picture at its maximum size, including wide screen cinema format picture.

Note:

Be aware that if you put the display in a public place for commercial purposes or a public showing and then use the aspect mode select function to shrink or expand the picture, you may be violating the copyright under copyright law. It is prohibited to show or alter the copyrighted materials of other people for commercial purposes without the prior permission of the copyright holder.



Press repeatedly to move through the aspect options:
For details about the aspect mode, please see "List of Aspect Modes" (page 71).

For VIDEO (S VIDEO) signal input:

→ 4:3 → ZOOM → FULL → JUST →

[from the unit]

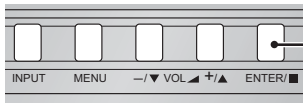

The aspect mode changes each time the ENTER button is pressed.

For PC signal input:

→ 4:3 → ZOOM → FULL →

For SD signal input (525 (480) / 60i • 60p, 625 (575) / 50i • 50p):

→ 4:3 → ZOOM → FULL → JUST →

For HD signal input [1125 (1080) / 60i • 50i • 60p • 50p • 24p • 25p • 30p • 24sF, 1250 (1080) / 50i, 750 (720) / 60p • 50p]:

→ 4:3 → H-FILL → ZOOM → FULL → JUST →

[For 3D images]

The aspect is fixed as "FULL" and you cannot switch.

Notes:

- The aspect mode is memorized separately for each input terminal.
- Do not allow the picture to be displayed in 4:3 mode for an extended period, as this can cause a permanent image retention to remain on the Plasma Display Panel.

All Aspect mode

Set "All Aspect" to "On" in Options menu to enable the extended aspect mode (page 60). When All Aspect mode, the aspect mode of pictures is switched as follows. For details about the aspect mode, please see "List of Aspect Modes" (page 71).

For VIDEO (S VIDEO) signal input:

→ 4:3 → Zoom1 → Zoom2 → Zoom3 → 16:9 → 14:9 → Just →

For PC signal input:

→ 4:3 → Zoom → 16:9 →

For SD signal input (525 (480) / 60i • 60p, 625 (575) / 50i • 50p):

→ 4:3 → Zoom1 → Zoom2 → Zoom3 → 16:9 → 14:9 → Just →

For HD signal input [1125 (1080) / 60i • 50i • 60p • 50p • 24p • 25p • 30p • 24sF, 1250 (1080) / 50i, 750 (720) / 60p • 50p]:

→ 4:3 Full → Zoom1 → Zoom2 → Zoom3 → 16:9 → 14:9 → Just1 → Just2 → 4:3 (1) → 4:3 (2) →



Digital Zoom

This displays an enlargement of the designated part of the displayed image. To use this function, go to "FUNCTION BUTTON SETTINGS" in the SETUP menu and set this function to the FUNCTION button (see page 56).

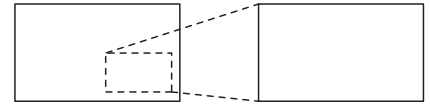

1 Display the operation guide.

FUNCTION **1** - **8** Press to access Digital Zoom.
The operation guide will be displayed.

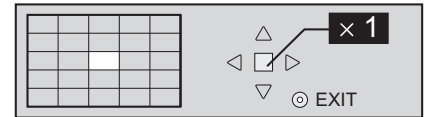

During Digital Zoom, only the following buttons can be operated.

[Unit]

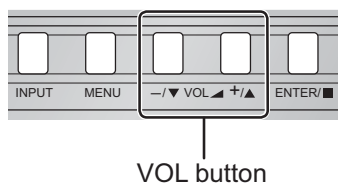

2 Select the area of the image to be enlarged.

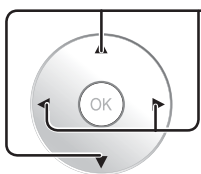

Press on the enlargement location to select.

The cursor will move.

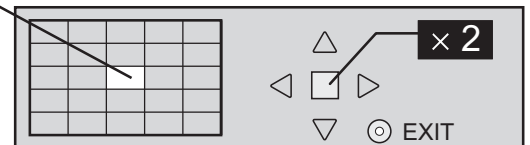
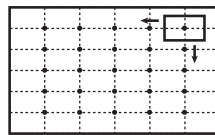

3 Select the magnification required for the enlarged display.

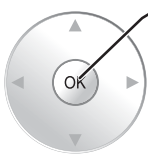

Each time this is pressed, the magnification factor changes.
This is shown in the image being displayed.

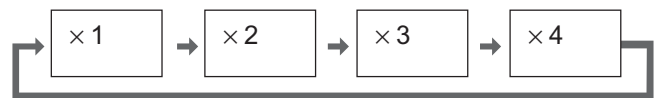

4 Return to normal display (quit Digital Zoom).

FUNCTION **1** - **8** or **RETURN** Press to exit from the Digital Zoom.

Notes:

- When power goes OFF (including "Off Timer" operation), Digital Zoom terminates.
- The Digital Zoom function cannot be selected while in the following operation state:
When SCREENSAVER is running. (see page 51)
- While Digital Zoom is in operation, "Adjusting POS./SIZE" cannot be used.

Viewing 3D images

You can enjoy viewing 3D images with contents or programmes compatible with 3D effect by using the 3D eyewear (optional).

Note:

You need the 3D IR TRANSMITTER (optional) and the 3D eyewear (optional) to view the 3D images on this display. For further information, see the instruction manuals of the 3D IR TRANSMITTER and the 3D eyewear.

This display supports "Frame Sequential"¹, "SIDE BY SIDE"², "TOP AND BOTTOM"³ and "SIMULTANEOUS"⁴ 3D formats.

*1: The 3D format that the images for the left and right eyes are recorded with the high definition quality and alternately played back

*2, *3: See "Table of images that can be seen for each 3D Picture Format and the source image format" on page 24.

*4: To view "SIMULTANEOUS" 3D images, one of the following terminal boards should be installed:

Dual HD-SDI Terminal Board for 3D (TY-FB30DHD3D), Dual DVI-D Terminal Board for 3D (TY-FB30DD3D)

To view the 3D images

To view the contents of the Frame Sequential format (ex. 3D-compatible Blu-ray Disc, etc.) with 3D effect

Connect the 3D-compatible player via an HDMI cable (see page 13) and playback the contents.

- Use fully wired HDMI compliant cable.
- For the settings of the player, read the manual of the player.
- If you use the non 3D-compatible player, the images will be displayed without 3D effect.

To view the contents of 3D formats other than Frame Sequential with 3D effect.

Match the picture format in "3D INPUT FORMAT" (see page 44) before viewing.

- You can view "SIDE BY SIDE" and "TOP AND BOTTOM" with 3D effect even if you use the non 3D-compatible player.
- Please consult the suppliers of contents or programmes for availability of this service.

① **Turn the 3D Eyewear on**

- See the instruction manual of 3D eyewear for handling.

② **Put on the 3D Eyewear**

③ **Watch the 3D images**

Notes:













- If the room is lit by fluorescent lights and light appears to flicker when using the 3D Eyewear, switch off the fluorescent light. Alternatively, please set "3D REFRESH RATE" to "100Hz" or "120Hz" whichever reduces flicker. (see page 46)
- 3D content will not be correctly visible if the 3D Eyewear is worn upside down or back-to-front.
- Do not wear the 3D Eyewear when watching anything other than 3D images. Liquid crystal displays (such as computer screens, digital clocks or calculators, etc.) may be difficult to see while wearing the 3D Eyewear.
- Do not use the 3D Eyewear as sunglasses.
- 3D effects may be perceived differently depending on the person.

Troubleshooting for 3D Eyewear

Symptoms	Checks
Cannot see 3D images	<ul style="list-style-type: none"> • Has the 3D Eyewear been switched On? • Ensure that “3D FUNCTION” in “3D SETTINGS” is set to “ON”. (see page 44) • Some 3D image signals may not be automatically recognized as 3D images. Set “3D INPUT FORMAT” in “3D SETTINGS” to match the picture format. (see page 44) • Check if 3D IR TRANSMITTER is turned on and corrected properly. • Check that there are no obstacles between the 3D IR TRANSMITTER and the 3D Eyewear. If the 3D Eyewear stops receiving the infrared signal for about 5 minutes, the 3D Eyewear will be turned off automatically. • Check the available area to use the 3D Eyewear. • Depending on the person, the 3D images may be difficult to see, or cannot be seen, especially in users that have a different level of eyesight between the left and right eyes. Take the necessary steps (wearing glasses etc.) to correct your eyesight before use.
3D Eyewear is turned off automatically	<ul style="list-style-type: none"> • Check that there are no obstacles between the 3D IR TRANSMITTER and the 3D Eyewear or that the 3D Eyewear is placed inside the coverage area. If the 3D Eyewear stops receiving the infrared signal for about 5 minutes, the 3D Eyewear will be turned off automatically.
There is something wrong with the 3D images	<ul style="list-style-type: none"> • Switch “SWAPPED” and “NORMAL” under “LEFT/RIGHT SWAP” in “3D SETTINGS” (see page 44).
Indicator lamp will not light when the 3D glasses are turned ON.	<ul style="list-style-type: none"> • The battery may be running low or flat. Change the battery or charge the 3D glasses.

Table of images that can be seen for each 3D Picture Format and the source image format

If the picture appears to be abnormal, refer to the table below to choose the correct 3D picture format setting.

3D INPUT FORMAT Source image format	AUTO	SIDE BY SIDE	TOP AND BOTTOM	NATIVE
Side by side	 *1	 Normal*2		
Top and bottom	 *1		 Normal*2	
Normal format (2D)	 Normal			 Normal

*1 When the source image is not recognized correctly

*2 When “3D FUNCTION” is set to “ON”, the images will be displayed with 3D effect. When set to “OFF”, displayed without 3D effect.

• Depending on the player or contents, the image may be different from the above illustrations.

On-Screen Menu Displays

1 Display the menu screen.

Remote Control



Unit

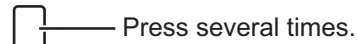

Each time the MENU button is pressed, the menu screen will switch.

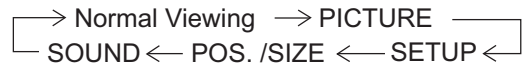

2 Select the menu.

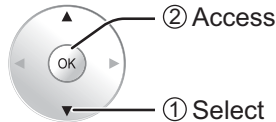
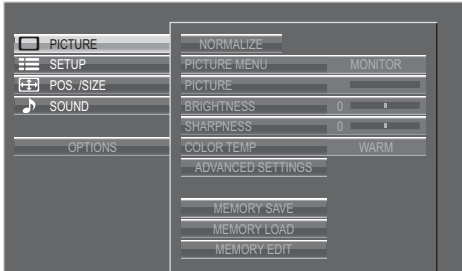

The menu can be displayed directly by pressing these buttons. (see page 26, 29)

3 Select the item.

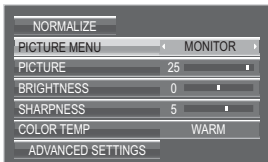

(Example: PICTURE menu)

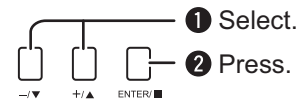

4 Set.

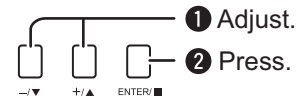
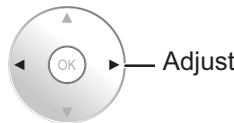

5 Exit the menu.

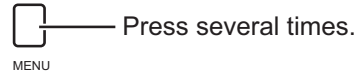

Press to return to the previous menu.

Menu display list

Note:

Menu that cannot be adjusted is grayout. Adjustable menu changes depending on signal, input and menu setting.

PICTURE menu

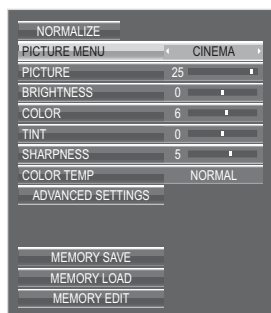

see page 29-38

SETUP menu

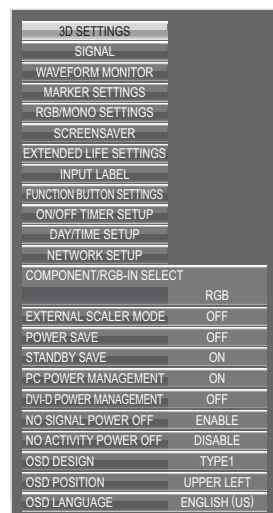

see page 40-58

POS./SIZE menu

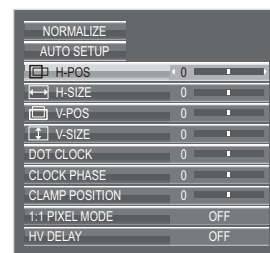

see page 26-28

SOUND menu

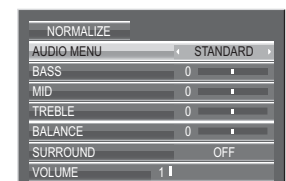

see page 39

Adjusting POS. /SIZE

1 Display the menu screen.



2 Select "POS. /SIZE".

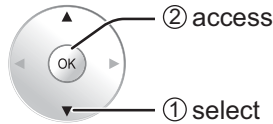
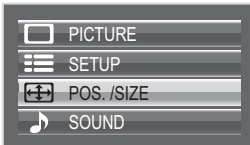

3 Select the item and set.

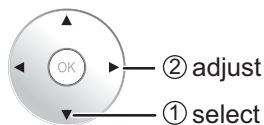
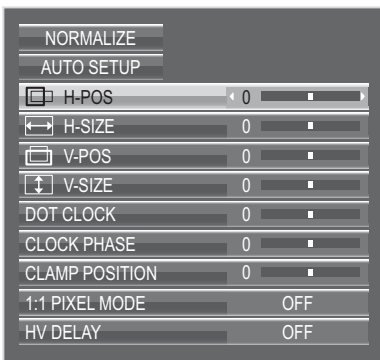

Note:

Unadjustable items are grayed out. Adjustable items differ depending on the input signal and the display mode.

4 Exit the menu.



To display a menu for adjustment of the POS. /SIZE menu on the bottom of the screen →

To hide the menu →

Notes:

- Adjustment details are memorized separately for different input signal formats. (Adjustments for component signals are memorized for 525 (480) / 60i · 60p, 625 (575) / 50i · 50p, 1125 (1080) / 60i · 50i · 60p · 50p · 24p · 25p · 30p · 24sF, 1250 (1080) / 50i, 750 (720) / 60p · 50p each, and RGB/PC/Digital signals are memorized for each frequency.)
- If a "Cue" or "Rew" signal from a VCR or DVD player is received, the picture position will shift up or down. This picture position movement cannot be controlled by the POS. /SIZE function.

Helpful Hint (NORMALIZE Normalization)

While the POS. /SIZE display is active, if the OK button is pressed during "NORMALIZE", then all adjustment values are returned to the factory settings.

- **AUTO SETUP** When inputting a PC signal as an example, “H-POS/V-POS”, “H-SIZE/V-SIZE”, “DOT CLOCK” and “CLOCK PHASE” are automatically corrected.
This setting is enabled under the following conditions:
 - This setting is not activated during Digital Zoom.
 - When inputting an analog signal (Component/PC):
This setting is enabled if “COMPONENT/RGB-IN SELECT” (see page 40) in SETUP menu is “RGB”.
 - When inputting a digital signal (HDMI/DVI):
A PC format signal enables this setting.
When the signal is not PC format, this setting is enabled only if “OVER SCAN” (see page 28) is “OFF” or “1:1 PIXEL MODE” (see page 28) is “ON.” H-SIZE/V-SIZE is not automatically adjusted.
This setting will be invalid and will not work under the following conditions:
 - When VIDEO signal input
 - Aspect is set to “JUST”
 - “Display size” in the OPTIONS menu (see page 60) is set to “On”

Using Remote Control



When **AUTO SETUP** on the remote control is pressed, “AUTO SETUP” will be executed.
When **AUTO SETUP** does not work, “INVALID” is displayed.

Auto mode

When the “Auto Setup” is set to “Auto” in the OPTIONS menu (see page 61), automatic position adjustment starts:

- When the display power is turned ON.
- When the input signal is switched.

Notes:

- If the dot clock frequency of an analog signal is 162 MHz or higher, “DOT CLOCK” and “CLOCK PHASE” cannot be automatically corrected.
- When digital signal input, DOT CLOCK and CLOCK PHASE cannot be made.
- AUTO SETUP may not work when a cropped or dark image is input. In such case, switch to a bright image with borders and other objects are clearly shown, and then try auto setup again.
- Depending on the signal, out of alignment may occur after AUTO SETUP. Carry out fine tuning for the position/size as required.
- If AUTO SETUP cannot set properly for vertical frequency 60Hz XGA signal (1024×768@60Hz, 1280×768@60Hz, and 1366×768@60Hz), pre-selecting the individual signal in “XGA MODE” (see page 45) may results in correct AUTO SETUP.
- AUTO SETUP does not work well when a signal such as additional information is superimposed out of valid image period or intervals between synchronizing and image signals are short, or for image signal with tri-level synchronizing signal added.
- If AUTO SETUP cannot adjust correctly, select “NORMALIZE” once and press OK button then adjust POS. /SIZE manually.

- **H-POS**

Adjust the horizontal position.

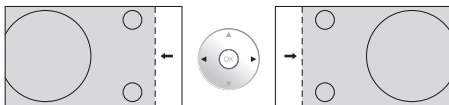

- **V-POS**

Adjust the vertical position.

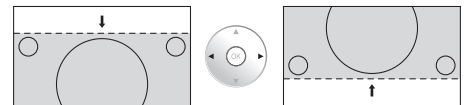

- **H-SIZE**

Adjust the horizontal size.

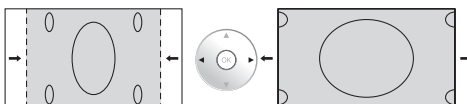

- **V-SIZE**

Adjust the vertical size.

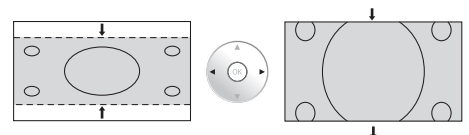

- **DOT CLOCK (During Component/PC input signal)**

Periodic striped pattern interference (noise) may occur when a striped pattern is displayed. If this happens, adjust so that any such noise is minimized.

- **CLOCK PHASE (During Component/PC input signal)**

Eliminate the flickering and distortion.

Adjusting POS. /SIZE

- OVER SCAN** Turn image over scan ON/OFF.
 Configurable signals are as follows:
 525i, 525p, 625i, 625p, 750/60p, 750/50p (Component Video, RGB, DVI, SDI, HDMI)

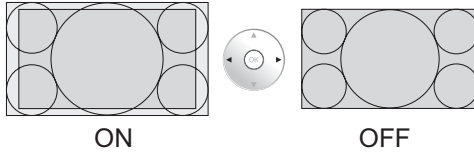

Notes:

- When “OFF” is set, “H-SIZE” and “V-SIZE” cannot be adjusted.
- When the “Display size” is set to “On” in the OPTIONS menu, this setting will be invalid.

- CLAMP POSITION (During Component/PC input signal)**

Adjusts the clamp position when black parts of the image have no detail due to underexposure or are tinged with green.

Optimum value for Clamp Position adjustment

When black parts have no detail due to underexposure (blackout)

→Value that causes least blackout is the optimum.

When black parts are tinged with green

→Value that cancels the greenishness without causing blackout is the optimum.

- 1:1 PIXEL MODE** Adjusts the display size when 1125i, 1125p or 1250i signal is input.

Notes:

- Select ON when you would like to replay 1920 × 1080 input signal.
- Applicable input signal;
1125 (1080) / 50i · 60i · 24sF · 24p · 25p · 30p · 50p · 60p, 1250 (1080) / 50i
- Select OFF when flickering is shown around the image.
- H-SIZE and V-SIZE cannot be adjusted when ON is selected.

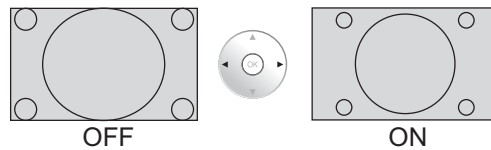

- 1:1 PIXEL MODE (2k1k)** When the input signal is a 2k1k signal (2048×1080 / 24p, 2048×1080 / 24sF), the display size is adjusted as follows.
 (For 2k1k signals)

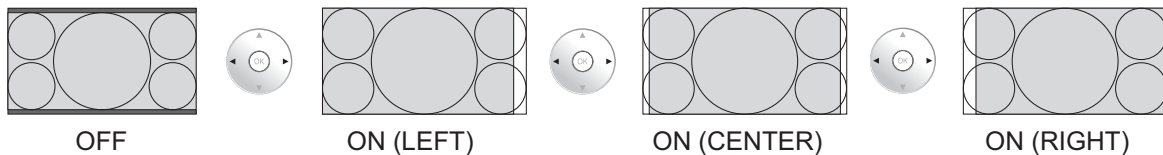

Note:

2k1k signals can only be received when the Dual Link HD-SDI Terminal Board (TY-FB11DHD) or the Dual HD-SDI Terminal Board for 3D (TY-FB30DHD3D) is installed.

- HV DELAY (During Component [video format] / SDI input signal)**

Video blanking period is displayed.

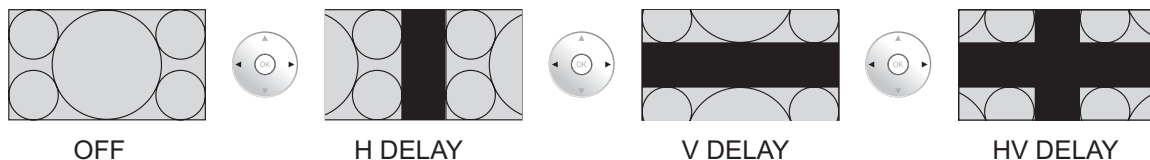

Notes:

- This function is enabled when “Studio mode” in OPTIONS menu is set to “On” during 2D viewing.
- This function can also be used with the FUNCTION button on the remote control (see page 63).

PICTURE Adjustments

1 Display the menu screen.



2 Select "PICTURE".

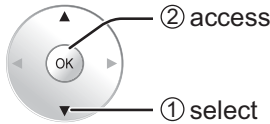
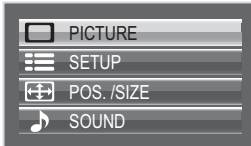

3 Select the item and set.

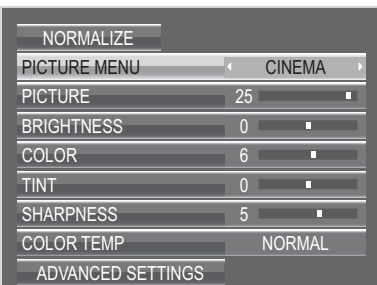

Note:

Menu that cannot be adjusted is grayout. Adjustable menu changes depending on signal, input and menu setting.

4 Exit the menu.



To display a menu for adjustment of the PICTURE menu on the bottom of the screen,

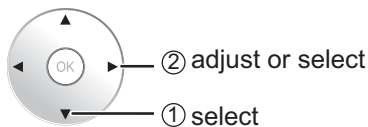

To display a menu for ADVANCED SETTINGS adjustment, press PICTURE button again.



To hide the menu



Helpful Hint (NORMALIZE Normalization)

While the "PICTURE" menu is displayed, if the OK button is pressed during "NORMALIZE", then all adjustment values are returned to the factory settings.

PICTURE Adjustments

● PICTURE MENU

You can switch to the optimal picture mode for the video source and viewing environment.

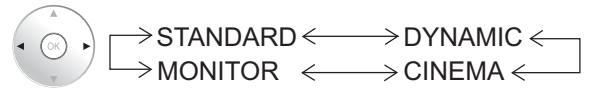

STANDARD:

For viewing in standard (evening lighting) environments. This menu selects the normal levels of BRIGHTNESS and PICTURE.

DYNAMIC:

For viewing in brighter environments. This menu selects higher than normal levels of BRIGHTNESS and PICTURE.

Notes:

- When "MONITOR" is selected in PICTURE MENU, the following menu items cannot be set.
 PICTURE menu: PICTURE
 EXTENDED LIFE SETTINGS: PEAK LIMIT (see page 54)
 SETUP menu: POWER SAVE (see page 42)
- If you would like to change the picture and color of the selected PICTURE MENU to something else, adjust using the items in the PICTURE menu. (see below)

CINEMA:

For use in viewing tone-focused pictures with brightness reduced.

MONITOR:

For use when creating broadcast or movie content. With this picture, even if the overall average picture level (APL) changes, the brightness of areas with the same signal level does not change.

● **PICTURE** Adjusts the proper picture contrast.



● **BRIGHTNESS** Adjusts for easier viewing of dark pictures such as night scenes and black hair.



● **COLOR** Adjusts color saturation.



● **TINT** Adjusts for natural flesh tones.



● **SHARPNESS** Adjusts picture sharpness.



● **COLOR TEMP** Switches to various screen color tones.

NORMAL: Intermediate color temperature (9300K).

WARM: Colors with a reddish tinge (6500K).

WARM2: Colors with a reddish tinge (6100K).

WARM3: Colors with a reddish tinge (5600K).

STUDIO: Optimal color temperature for studio viewing (3200K).

COOL: Colors with a bluish tinge (11500K).

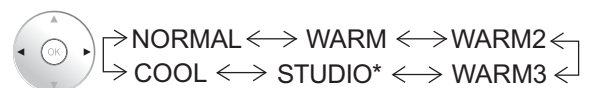

*"STUDIO" can be modified when "Studio mode" in the OPTIONS menu is "On". (see page 59)

Notes:

- You can change the level of each function (PICTURE, BRIGHTNESS, COLOR, TINT, SHARPNESS) for each PICTURE MENU.
- The setting details for STANDARD, DYNAMIC, CINEMA and MONITOR respectively are memorized separately for each input terminal.
- In PICTURE, there is not a noticeable change even when contrast is increased with a bright picture or reduced with a dark picture.

ADVANCED SETTINGS

Enables fine picture adjustment at a professional level.

Notes:

- The adjustment values are memorized separately for each input terminal.
- The adjustment range values should be used as an adjustment reference.

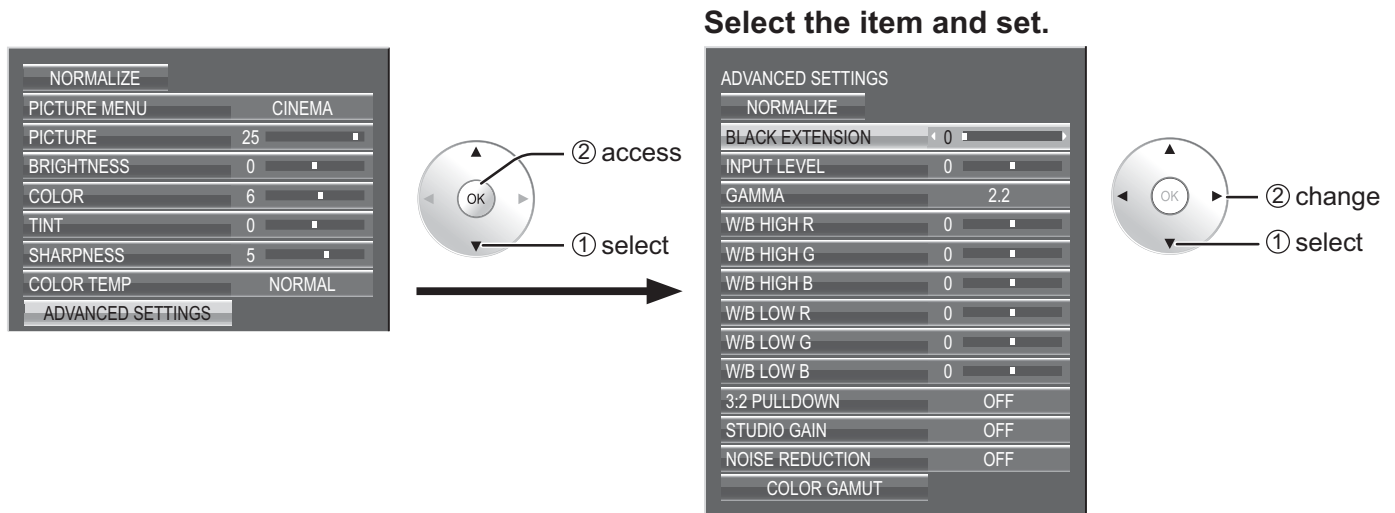

● **BLACK EXTENSION** Adjusts the dark shades of the image in gradation.

● **INPUT LEVEL** Adjustment of parts which are extremely bright and hard to see.

● **GAMMA** > 1.0* <—> 2.2 <—> 2.35 <—> 2.4 <—> 2.6 <—

* When 2k1k signals are received with the Dual Link HD-SDI Terminal Board (TY-FB11DHD) or Dual HD-SDI Terminal Board for 3D (TY-FB30DHD3D), GAMMA “1.0” cannot be selected.

● **“W/B” adjustment**

W/B HIGH R	◀ 0	Adjusts the white balance for light red, light green or light blue areas.
W/B HIGH G	◀ 0	
W/B HIGH B	◀ 0	
W/B LOW R	◀ 0	Adjusts the white balance for dark red, dark green or dark blue areas.
W/B LOW G	◀ 0	
W/B LOW B	◀ 0	

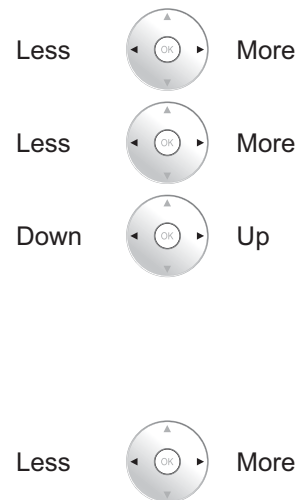

Carry out “W/B” adjustment as follows.

1. Adjust the white balance of the bright sections using the “W/B HIGH R” , “W/B HIGH G” and “W/B HIGH B” settings.
2. Adjust the white balance of the dark sections using the “W/B LOW R” , “W/B LOW G” and “W/B LOW B” settings.
3. Repeat steps 1 and 2 to adjust.

Steps 1 and 2 affect each other’s settings, so repeat each step in turn to make the adjustment.

PICTURE Adjustments

- 3:2 PULLDOWN** When "ON", the display attempts to reproduce a more natural interpretation of sources such as movie pictures, which are recorded at 24 frames per second. If the picture is not stable, turn the setting to "OFF".

OFF  ON

Note:

When "ON", this setting only affects the following signal input:

- NTSC / PAL signal input during Video (S Video) input signal.
- 525i (480i), 625i (575i), 1125 (1080) / 60i signal input during "COMPONENT" input signal.

- STUDIO GAIN** Sharpens the contrast for a better view when a part of the image is too light to see.

OFF  ON

OFF: Disables "STUDIO GAIN".
ON: Enables "STUDIO GAIN".

Notes:

- "STUDIO GAIN" can be modified when "Studio mode" in the OPTIONS menu is "On". When "Studio mode" is "Off", this setting is "OFF" and cannot be changed. (see page 59)
- This setting is valid only when the input signals are as follows:
 Component Video, RGB (analog), SDI, HDMI

- NOISE REDUCTION** Sets the following three NR (Noise Reduction) functions together.
 VIDEO NR, BLOCK NR, MOSQUITO NR

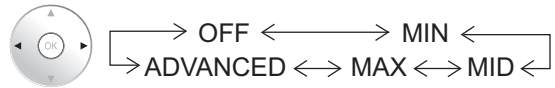

[Advanced NR]

Sets the three NR functions separately.

1 Select "ADVANCED".

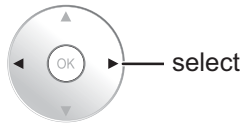

2 Select the item and set.

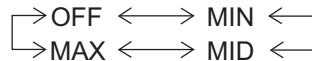
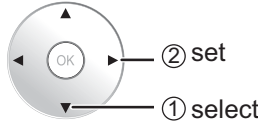
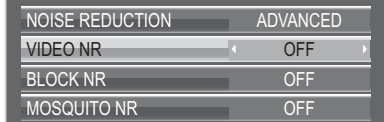

- VIDEO NR:** Automatically reduces unwanted picture noise.
- BLOCK NR:** Reduces block noise when playing MPEG videos.
- MOSQUITO NR:** Reduces mosquito noise around subtitles on MPEG videos.

Note:

"NOISE REDUCTION" cannot be adjusted while a PC signal is being applied.

Helpful Hint (NORMALIZE Normalization)

On the remote control unit, while the "ADVANCED SETTINGS" menu is displayed, if the OK button is pressed during "NORMALIZE", then all adjustment values are returned to the factory settings.

Color space adjustment (COLOR GAMUT)

Changes the color space to BT.709 signal standard chromaticity point and fine-tunes it.

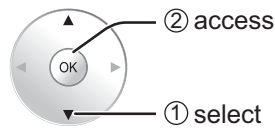
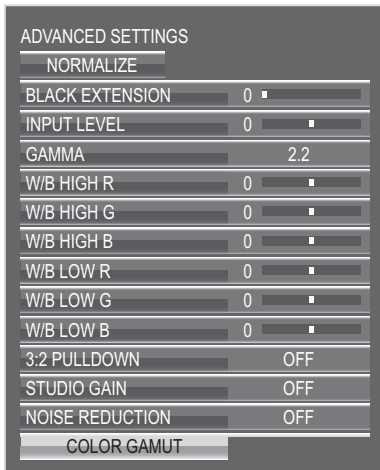

Select the item and set.

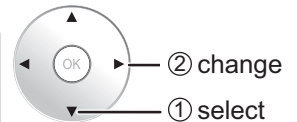
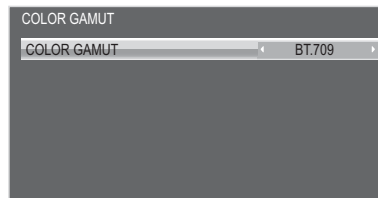

• COLOR GAMUT

DIGITAL CINEMA COLOR: Sets color gamut to reproduce the original color of movies.

CUSTOM: Enables the color space adjustment, the color space adjustment (default value: BT.709) set in the “EDIT” is reflected.

NATIVE: Disables the color space adjustment, images are displayed in the original color gamut of the panel.

BT.709: Changes the color space to BT.709 signal standard chromaticity point.

EBU: Changes the color space to EBU signal standard chromaticity point.

SMPTE-C: Changes the color space to SMPTE-C signal standard chromaticity point.

Notes:

- This setting is memorized separately for each input terminal and “PICTUR MENU”.
- For 3D images, this setting becomes “OFF” and no setting is available.

• EDIT

Color space is fine-tuned.

Notes:

- This setting is valid when “COLOR GAMUT” is “CUSTOM”.
- This setting is memorized separately for each input terminal and “PICTUR MENU”.

1 Select “EDIT”.

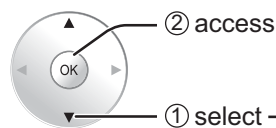

2 Select an adjustment item.

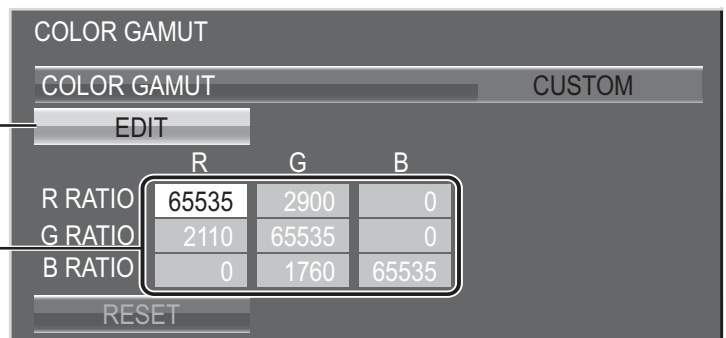
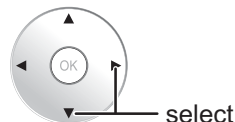

3 Change the numerical value. 65535

[To adjust with the ▲▼ button]

- 1 Press the button.
- 2 Change the numerical value with the ▲▼ button.
- 3 Press the button.

[To input the numerical value directly]

- 1 Input the numerical value from to .
- Pressing the will cancel the value change.
- 2 Press the button.

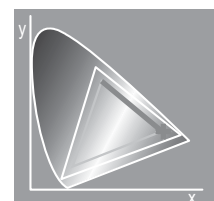

Chromaticity diagram displays in gray the dot and line to be adjusted.

4 Press the button.
Adjustment is ended.

PICTURE Adjustments

- **RESET** Resets the adjustment value of color space.

Note:

This setting is reflected only for the selected input terminal and the "PICTUR MENU".

- 1 Select "RESET".

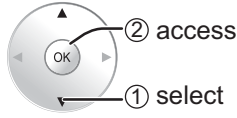
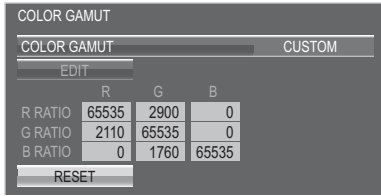

- 2 Select "OK".

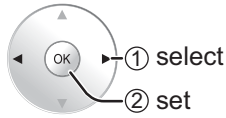
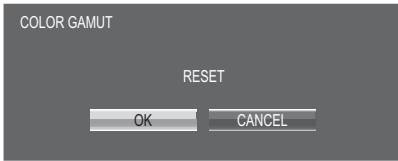

- **Chromaticity diagram** The RGB triangle representing current color space is shown.

COLOR GAMUT: CUSTOM

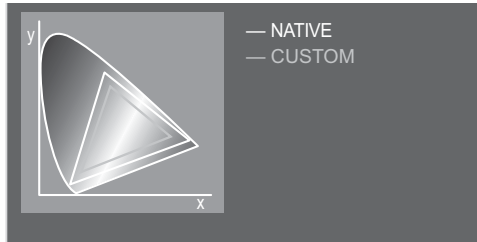

White line: Color gamut with "NATIVE" setting (original color gamut.)
 Yellow line: Color gamut with "CUSTOM" setting (current color gamut.)

Picture Profiles

Up to 16 combinations of picture adjustment values (in the PICTURE menu and ADVANCED SETTINGS) can be stored in the display memory as profiles and applied as needed, for a convenient way to enjoy your preferred picture settings.

Note:

If setting items (PICTURE menu and ADVANCED SETTINGS) are set differently between MEMORY SAVE and MEMORY LOAD, they may not reflect for MEMORY LOAD.

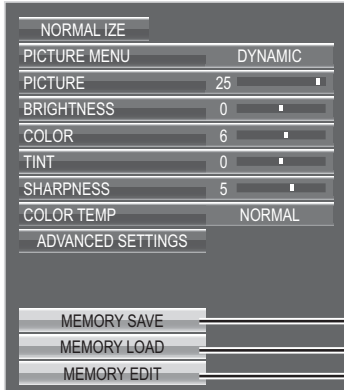

Save profiles (page 36)
Load profiles (page 37)
Edit profiles (page 38)

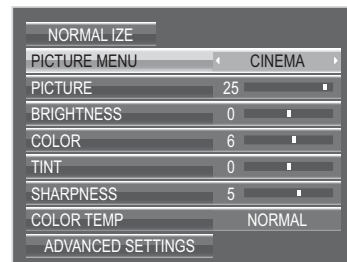

Save profiles



Save the picture adjustment values in the MEMORY1 profile

Edit the profile
Delete or rename the profile

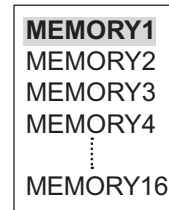
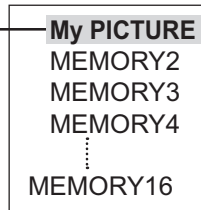

Load the profile



Apply the MEMORY1 profile

Original picture

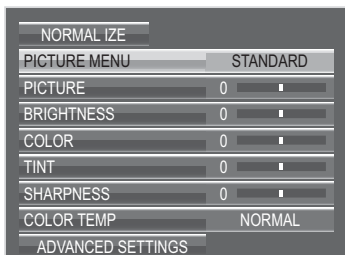

Custom picture

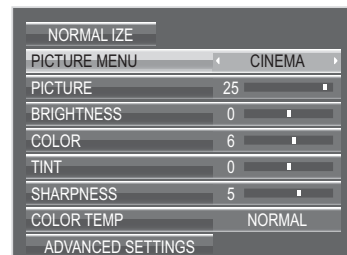

Saving profiles

Follow these steps to save picture adjustment values as profiles.

Note:

When the settings are locked in “EXTENDED LIFE SETTINGS”, profiles cannot be saved.

1 Specify the picture quality in the PICTURE menu and ADVANCED SETTINGS. (see page 29-34)

2 In the PICTURE menu, select “MEMORY SAVE”.



3 Select a profile name for saving the picture adjustment values.

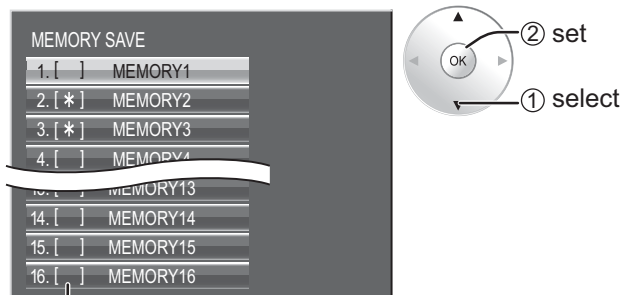

“*” appears for a profile in which the picture adjustments have already been saved.

4 Select “OK”.

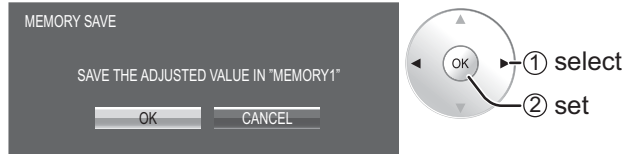

5 Enter a name for the profile.
[Entering profile names]

Profile names can be up to 40 characters.

To enter text, select characters in the on-screen keyboard.

Edit the default profile name in the text box as desired.

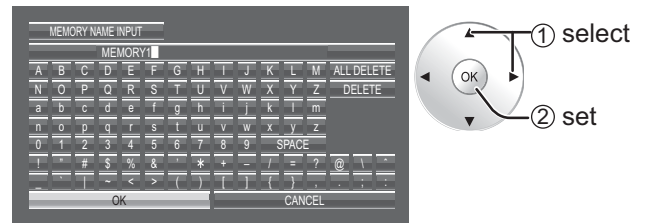

Example: Specifying “MY PICTURE”

① Select “ALL DELETE”.



All text is deleted.

To delete individual characters, select “DELETE”.

② Select “M”.



Repeat this process to enter the next character.

③ Select “Y”.



④ Select “SPACE”.



6 When you finished entering the profile name, select “OK”.

To cancel saving the profile, select “CANCEL”.

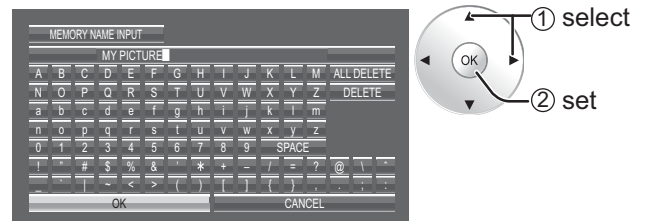

Loading profiles

Load profiles and apply the picture adjustment values to the display as follows.

Notes:

- Loaded profiles are stored in memory according to the selected input interface. (see page 18)
- When the settings are locked in “EXTENDED LIFE SETTINGS”, profiles cannot be loaded.

<Loading profiles from the PICTURE menu>

1 In the PICTURE menu, select “MEMORY LOAD”.



2 Select the profile to load.



<Loading profiles directly from the remote control>

To load profiles 1–9

1 Press a button in the range **1–9**.

2 Select “OK”.

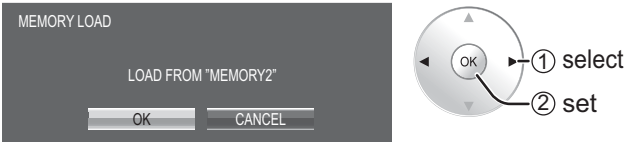

To load profiles 10–16
Example: To load profile 16

1 Press **MEM LOAD 1 6**.

The profile number is displayed in the upper-right corner of the screen.



2 Select “OK”.

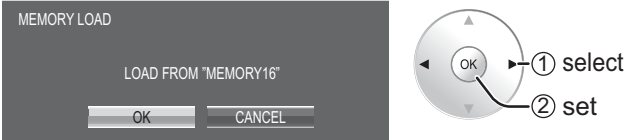

<Loading profiles from  on the remote control>

1 Press  to list the profiles.

2 Select the profile to load.



When profile is being loaded, profile name is displayed.

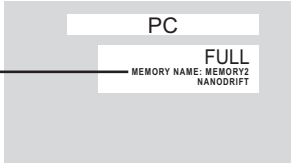



Editing profiles

Delete or rename profiles as follows.

<Deleting profiles>

- 1** In the PICTURE menu, select "MEMORY EDIT".

- 2** Select "MEMORY DELETE".



- 3** Select the profile to delete.
To delete all profiles, select "ALL DELETE".

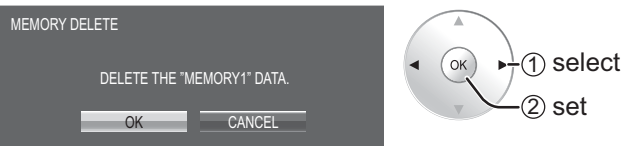

- 4** Select "OK".



<Renaming profiles>

- 1** In the PICTURE menu, select "MEMORY EDIT".

- 2** Select "MEMORY NAME CHANGE".

- 3** Select the profile to rename.

- 4** Enter a name for the profile.
Entering profile names → page 36

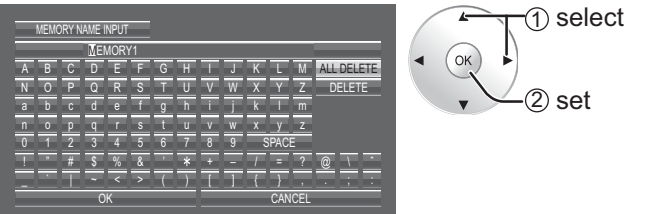
- 5** When you finished entering the profile name, select "OK".
To cancel renaming the profile, select "CANCEL".



SOUND Adjustment

1 Display the menu screen.



2 Select "SOUND".

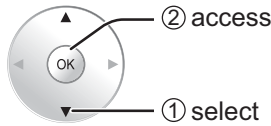
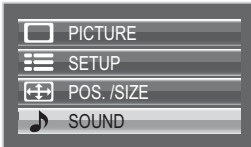

3 Select the item and set.

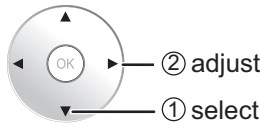
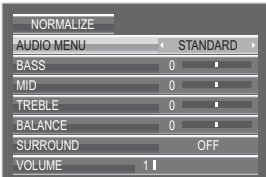

4 Exit the menu.



Item	Details
AUDIO MENU	STANDARD: Emits the original sound. DYNAMIC: Accentuates sharp sound. CLEAR: Attenuates human voice.
BASS	Adjusts low pitch sounds.
MID	Adjusts normal sounds.
TREBLE	Adjusts high pitch sound.
BALANCE	Adjusts left and right volumes.
SURROUND	Select ON or OFF.
VOLUME	Adjust the sound volume level.

Note: BASS, MID, TREBLE and SURROUND settings are memorized separately for each AUDIO MENU.

Helpful Hint (NORMALIZE Normalization)

While the "SOUND" menu is displayed, if the OK button is pressed during "NORMALIZE", then all adjustment values are returned to the factory settings.

SDI SOUND OUTPUT

This menu is available only when selecting a slot that any of the following terminal boards is installed: HD-SDI Terminal Board with audio (TY-FB10HD), Dual Link HD-SDI Terminal Board (TY-FB11DHD), or Dual HD-SDI Terminal Board for 3D (TY-FB30DHD3D)

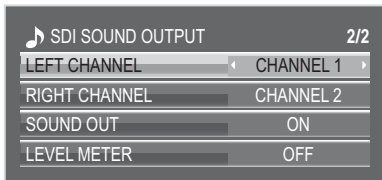

Item	Details
LEFT CHANNEL	CHANNEL 1 to CHANNEL 16 Selects left audio channel.
RIGHT CHANNEL	CHANNEL 1 to CHANNEL 16 Selects right audio channel.
SOUND OUT	ON <=> OFF ON: Enables audio output. OFF: Disables audio output.
LEVEL METER	OFF <=> 1-8CH <=> 9-16CH Sets audio channels to show in the audio level meter. 8 channels are displayed in the audio level meter; 4 channels each on both right and left sides of the display. OFF: Hides the audio level meter. 1-8CH: Displays the audio level meter (1-8ch) 9-16CH: Displays the audio level meter (9-16ch)

SETUP menu

1 Display the menu screen.



2 Select "SETUP".

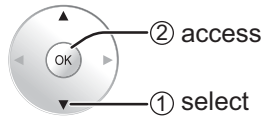
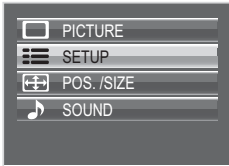

3 Select the item and set.

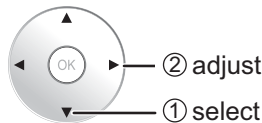
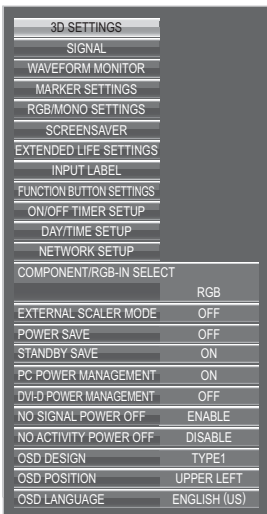

4 Exit the menu.



COMPONENT / RGB IN SELECT

COMPONENT \longleftrightarrow RGB

Select to match the signals from the source connected to the Component / RGB or PC input terminals.

Y, P_B, P_R signals \leftrightarrow "COMPONENT"

RGB signals \leftrightarrow "RGB"

Note:

Make setting of the selected input terminal (COMPONENT RGB IN or PC IN).

YUV / RGB IN SELECT

YUV \longleftrightarrow RGB

Select to match the signals from the source connected to the DVI input terminals.

YUV signals \leftrightarrow "YUV"

RGB signals \leftrightarrow "RGB"

Notes:

- Selection may not be possible, depending on which optional board is installed.
- Make setting of the selected input terminal (SLOT or DVI-D IN).

EXTERNAL SCALER MODE

OFF ←→ ON

This menu can be used to specify whether the built-in scaler or an external scaler is used for scaler functions such as resizing and picture quality adjustment.

The setting is valid with the following input signals.

1125 (1080) / 24p·25p·30p·50p·60p

OFF: Use the built-in scaler.

ON: Use an external scaler.

Note:

If "ON" is set when other than corresponding signal is input, "Input signal must be 1125p(1080p)" message is displayed.

Using Remote Control

"EXTERNAL SCALER MODE" can also be set with the FUNCTION button on the remote control (see page 63).

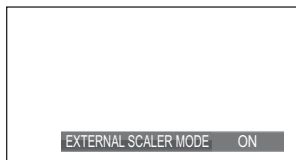

Note:

Selecting "ON" in this setting deactivates the following settings and disables these operations.

- | | |
|----------------------------------|---|
| POS. /SIZE menu: | H-SIZE, V-SIZE, 1:1 PIXEL MODE (see page 27, 28) |
| PICTURE menu: | BRIGHTNESS, COLOR, TINT, SHARPNESS, MEMORY SAVE, MEMORY LOAD
(see page 30, 36, 37) |
| ADVANCED SETTINGS: | 3:2 PULLDOWN, NOISE REDUCTION (see page 32) |
| SIGNAL menu: | XGA MODE (see page 45) |
| OPTIONS menu: | Display size, All Aspect (see page 60) |
| ASPECT Controls
(see page 21) | |

"EXT. SCALER" is displayed in the menu screen to indicate that an external scaler is in use.

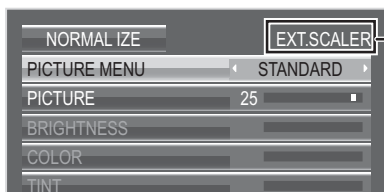

SETUP menu

POWER SAVE

OFF \longleftrightarrow ON

When this function is turned ON, luminous level of the Plasma Display is suppressed, so power consumption is reduced.

STANDBY SAVE

OFF \longleftrightarrow ON

When this function is turned ON, power consumption of the microcomputer is reduced during power supply standby (see page 16, 19, 20), so standby power of the set is reduced.

PC POWER MANAGEMENT

OFF \longleftrightarrow ON

When this function is set to ON, it operates under the following conditions to turn the power on or off automatically. When no pictures (HD/VD sync signals) are detected for 30 or so seconds during PC signal input:

→ Power is turned off (standby); the power indicator lights up orange.

When pictures (HD/VD sync signals) are subsequently detected:

→ Power is turned on; the power indicator lights up green.

Notes:

- This function operates only during PC signal input.
 - This function is effective when "SYNC" is set to "AUTO", "COMPONENT / RGB-IN SELECT" is set to "RGB".
-

DVI-D POWER MANAGEMENT

OFF \longleftrightarrow ON

When this function is set to ON, it operates under the following conditions to turn the power on or off automatically. When no pictures (sync signal) are detected for 30 or so seconds during DVI signal input:

→ Power is turned off (standby); the power indicator lights up orange.

When pictures (sync signal) are subsequently detected:

→ Power is turned on; the power indicator lights up green.

Notes:

- This function operates only during DVI signal input.
 - This function is invalid during input from DVI-D Terminal Board (TY-FB11DD) and Dual DVI-D Terminal Board for 3D (TY-FB30DD3D).
 - Depending on the type of terminal board equipped, this function may be invalid.
-

NO SIGNAL POWER OFF

DISABLE \longleftrightarrow ENABLE

Equipment power supply is turned OFF when there is no signal.

When this is set to "ENABLE", the power supply of the unit goes Off 10 minutes after the input signals stop.

NO ACTIVITY POWER OFF

DISABLE \longleftrightarrow ENABLE

When this function is set to "ENABLE", the power is turned off (standby) automatically when there is no operation of the Plasma Display for 4 hours.

Starting from 3 minutes before the turn off, the remaining time will be displayed.

When the power is turned off due to this function, a message "LAST TURN OFF DUE TO 'NO ACTIVITY POWER OFF'." is displayed next time the power is turned on.

Notes:

During the screensaver is running, this function is disabled.



OSD DESIGN

Choose the background color (transparency).

→TYPE1 ←→TYPE2 ←→TYPE3←

OSD POSITION

Choose the display position.

Note:

Each time you press ◀ or ▶, the on-screen menu display position changes.

Display example

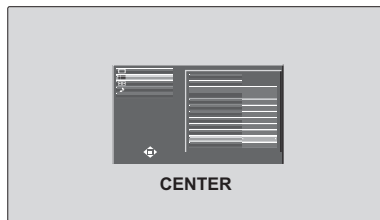
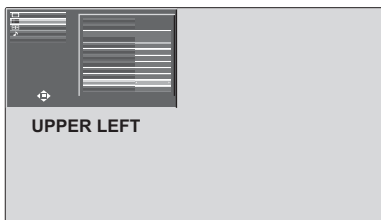

OSD LANGUAGE

Select your preferred language.

■ Selectable languages

- English(UK)
- Deutsch
- Français
- Italiano
- Español
- ENGLISH(US)
- 中文 (Chinese)
- 日本語 (Japanese)
- Русский (Russian)

SETUP menu

3D SETTINGS

To view the 3D images, please adjust and setup the 3D settings.

Note:

Set these settings for each input terminals.

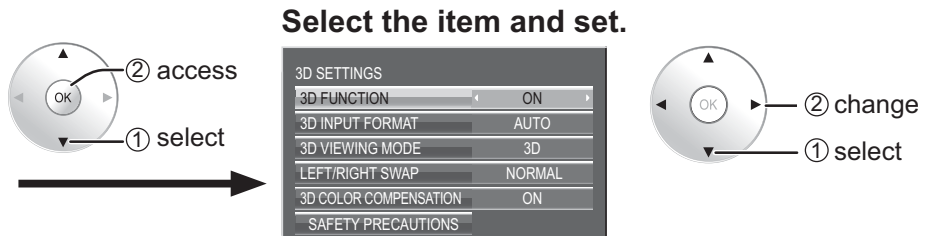
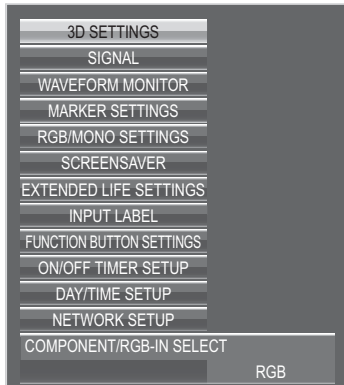

• 3D FUNCTION

ON \longleftrightarrow OFF

ON: To view the 3D images, please set it to "ON". You can see 3D images for 3D image signal and 2D images for 2D image signal.

OFF: You can see 2D images instead of 3D images.

When set to "ON", "3D" is displayed during 3D images.

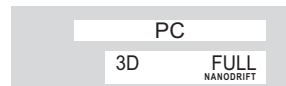

• 3D INPUT FORMAT

3D images method is set.

AUTO: 3D images are automatically displayed according to the signal.

SIDE BY SIDE/TOP AND BOTTOM: One of the formats of the 3D standard. Select these formats as necessary.

NATIVE: Displays the input signal as it is. Use to identify the format type of the input signal.

SIMULTANEOUS: Set this format when selecting a slot that one of the following terminal boards is installed:

Dual HD-SDI Terminal Board for 3D (TY-FB30DHD3D), Dual DVI-D Terminal Board for 3D (TY-FB30DD3D)

• 3D VIEWING MODE

The 3D images are separated and displayed as right and left images.

3D: Normal 3D images display (initial setting)

COMPARISON: Left image (L) and right image (R) are placed side by side. If the 3D system is "TOP AND BOTTOM", the images are displayed, being set one above the other.

LEFT: Only the left image (L) is displayed.

RIGHT: Only the right image (R) is displayed.

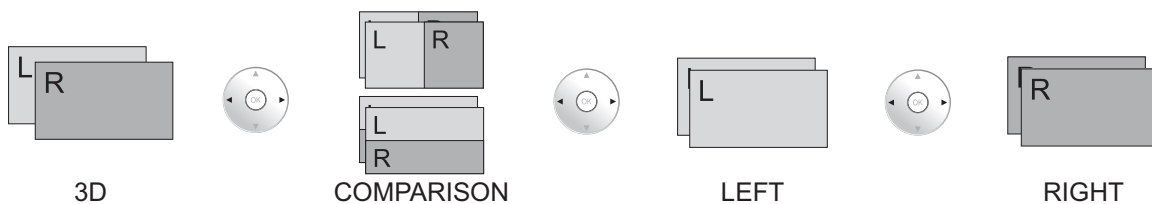

Note:

- This function is disabled during 2D images.
- The factory default setting is "3D". To view the 3D images, please use "3D"

• LEFT/RIGHT SWAP

NORMAL \longleftrightarrow SWAPPED

This function calibrates the timing to switch the right and left images as well as the timing to switch the shutter of right and left 3D Eyewear. Selects "SWAPPED" if you feel that the sense of depth is unusual.

• 3D COLOR COMPENSATION

ON \longleftrightarrow OFF

The color adjustment during the 3D images is set.

ON: The color when using the 3D Eyewear is adjusted. (initial setting)

OFF: The color when using the 3D Eyewear is not adjusted. The 2D image setting is used.

Note:

The factory default setting is "ON". To view the 3D images, please set it to "ON".

• SAFETY PRECAUTIONS

Displays the precautions for viewing 3D images.

SIGNAL menu

Note:

“SIGNAL” setup menu displays a different setting condition for each input signal.

Select the item and set.

For VIDEO (S VIDEO)

SIGNAL	[VIDEO]
FRAME CREATION	MID
COLOR SYSTEM	AUTO

For COMPONENT

SIGNAL	[COMPONENT]
FRAME CREATION	MID
XGA MODE	AUTO
H-FREQ.	33.7 kHz
V-FREQ.	60.0 Hz
SIGNAL FORMAT	1125(1080)60i

For RGB

SIGNAL	[RGB]
FRAME CREATION	MID
SYNC	AUTO
XGA MODE	1024 x768
H-FREQ.	33.7 kHz
V-FREQ.	60.0 Hz
SIGNAL FORMAT	1125(1080)60i

For Digital (Example: DVI input)

SIGNAL	[Digital]
FRAME CREATION	MID
H-FREQ.	33.7 kHz
V-FREQ.	60.0 Hz
DOT CLOCK-FREQ.	108.0 MHz
SIGNAL FORMAT	1125(1080)60i

Input signal display
Displays the frequency and the type of the current input signal. This display is valid only for COMPONENT/RGB/PC and Digital input signal. Display range:
Horizontal 15 - 110 kHz
Vertical 48 - 120 Hz
The dot clock frequency is displayed during DVI signal input.

• **3D Y/C FILTER (NTSC)**

This menu is displayed when BNC Dual Video Terminal Board (TY-FB9BD) is installed to the unit. Set this menu when the moving image looks unnatural during Video (S Video) input signal.

ON ↔ **OFF**

Note:

When ON, this setting only affects NTSC input signals.

• **COLOR SYSTEM**

↔AUTO↔PAL↔SECAM↔M.NTSC↔NTSC↔

Set the color system to match the input signal. When “AUTO” is set, COLOR SYSTEM will be automatically selected from NTSC/PAL/SECAM/M.NTSC.

To display PAL60 signal, select “AUTO” or “PAL”.

If the image becomes unstable:

With the system set on Auto, under conditions of low level or noisy input signals the image may in rare cases become unstable. Should this occur, set the system to match the format of the input signal.

• **XGA MODE**

This menu is displayed when the input signal is analog (Component/PC).

This unit supports three types of XGA signals with 60Hz vertical frequency having different aspect ratios and sampling rates (1,024 × 768 @ 60Hz, 1,280 × 768 @ 60Hz and 1,366 × 768 @ 60Hz).

AUTO ↔ **1024×768** ↔ **1280×768** ↔ **1366×768**

AUTO: Automatically selected from 1024×768/1280×768/1366×768.

Switch the setting to suit the input signal for better display depends on the angle of view or display resolution condition.

Note:

After making this setting, be sure to make each adjustment (such as “AUTO SETUP”) on the “POS. /SIZE” menu as necessary. (see page 26)

SETUP menu

• SYNC

This function operates only during input from PC IN terminal.

Setting RGB sync signal

Confirm that the input is set to RGB input (this setting is valid only for RGB input signal).

AUTO: The H and V sync or synchronized signal is automatically selected. If both input, it is selected the H and V sync.



ON G: Uses a synchronized signal on the Video G signal, which is input from the G connector.



VBS: Uses a synchronized signal of Composite Sync input, which is input from the HD connector.

Setting Component sync signal

Confirm that the input is set to Component input (this setting is valid only for Component input signal).

AUTO: The H and V sync or synchronized signal is automatically selected. If both input, it is selected the H and V sync.



ON Y: Uses a synchronized signal on the Video Y signal, which is input from the Y connector.

Note:

Signals input to COMPONENT/RGB IN terminals correspond to SYNC ON G or SYNC ON Y.

• SDI THROUGH

Set the active through function of the Dual Link HD-SDI Terminal Board (TY-FB11DHD).

OFF ↔ ON

ON: Enables active through.

OFF: Disables active through.

Note:

Settings can only be performed for this menu when a slot mounted with a Dual Link HD-SDI Terminal Board (TY-FB11DHD) is selected.

• FRAME CREATION

Automatically compensates the picture frame rate and removes juddering movements to make the images smooth.

OFF ↔ MID ↔ MAX

Note:

Depending on the contents, images may be noisy. To prevent the noise, change the setting.

• 3D REFRESH RATE

Reduces juddering or flicker of image due to lighting interference during 3D viewing.

100Hz ↔ 120Hz

Note:

This setting is disabled when "FRAME CREATION" is set to "OFF".

• HDMI RANGE

Switches the dynamic range according to the input signal from HDMI terminal.

VIDEO(16-235) ↔ FULL(0-255) ↔ AUTO

VIDEO(16-235): If the input signal is the video range, Example: HDMI terminal output for DVD player

FULL(0-255): If the input signal is full range, Example: HDMI terminal output for personal computer

AUTO: Switches the dynamic range automatically between "VIDEO(16-235)" and "FULL(0-255)" according to the input signal.

Note:

This function can be set only for HDMI signal input.

• SDI SIGNAL FORMAT

This menu is available only when selecting a slot that the Dual HD-SDI Terminal Board for 3D (TY-FB30DHD3D) is installed and set the input signal format for the board.

AUTO ↔ YCbCr(4:2:2) 10bit ↔ YCbCr(4:2:2) 10bit 60p/50p ↔ YCbCr(4:4:4) 10bit ↔ RGB(4:4:4) 10bit
↔ YCbCr(4:2:2) 12bit ↔ YCbCr(4:4:4) 12bit ↔ RGB(4:4:4) 12bit ↔ XYZ(4:4:4) 12bit

AUTO: Automatically selects the signal format according to the input signal.

WAVEFORM MONITOR

The input signal from video equipment is displayed as waveforms so that the signal level can be checked.

Notes:

- This function is enabled when “Studio mode” in OPTIONS menu is set to “On”.
- This function is disabled during 3D images.
- Applicable input signal; HDMI, DVI, SDI

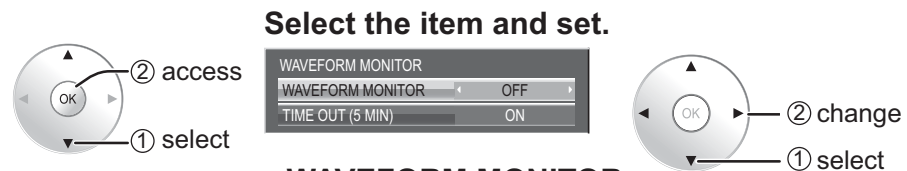
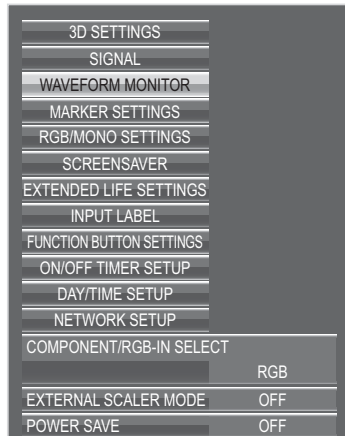

Select the item and set.

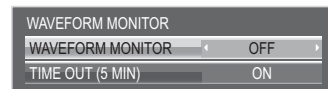

• **WAVEFORM MONITOR**

- ON: The waveform monitor is displayed.
- OFF: The waveform monitor is not displayed.

• **TIME OUT (5 MIN)**

- The waveform monitor display time-out is set.
- ON: The display of the waveform monitor disappears in 5 minutes.
- OFF: The waveform monitor display time-out does not occur.

Display of the waveform monitor

1 Set “WAVEFORM MONITOR” to “ON”.

The waveform monitor can also be displayed using the FUNCTION button on the remote control (see page 63).

2 **Exit the menu.**

3 Press **to switch the display mode.**

Notes:

- The display mode and display position of the waveform monitor are stored.
- The aspect is fixed as “FULL” during the waveform monitor display.

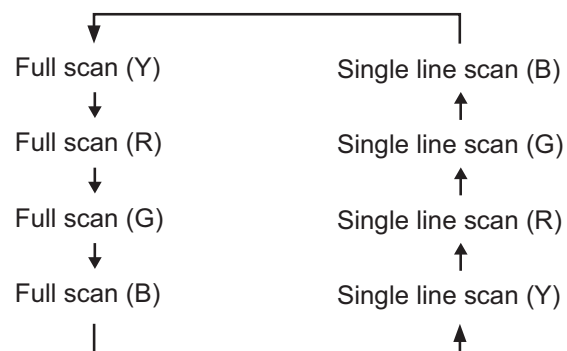

Full scan mode

The display position of the waveform monitor can be changed with the cursor button.

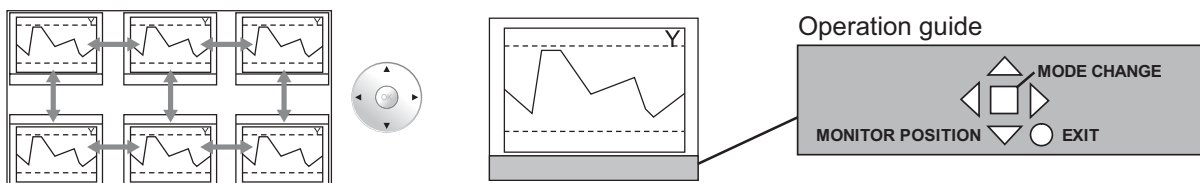

Single line scan mode

Scan line can be changed with the cursor button.

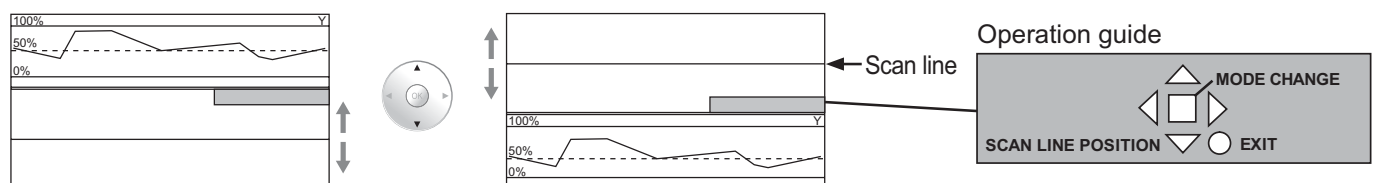

4 Press **to exit the waveform monitor.**

The waveform monitor ends after 5 minute time-out or by setting “WAVEFORM MONITOR” to “OFF”.

SETUP menu

MARKER SETTINGS

Various markers for editing image are displayed.

Notes:

- This function is available when “Studio mode” in OPTIONS menu is set to “On”
- This function is disabled during 3D images.
- An aspect of “4:3” or “FULL” is valid for this function. Only an aspect of “FULL” is valid at the input of HD signal.

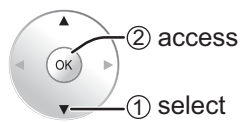
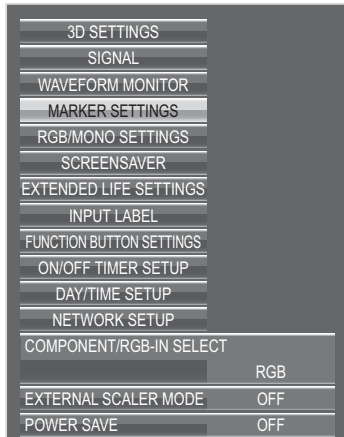

Select the item and set.

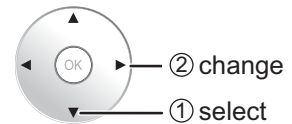
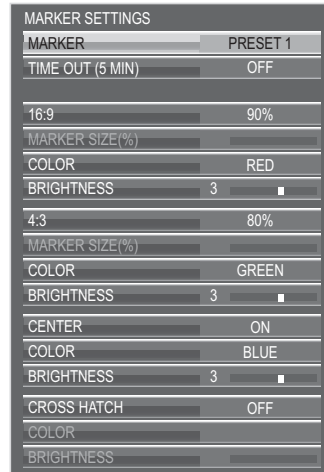

Marker display settings

• MARKER

Set show/hide of the marker.

OFF: The marker is not displayed.

PRESET1 / PRESET2: The marker is displayed by PRESET1 or 2 setting. You can configure the display setting of PRESET1/2.

- You can also display the marker with the FUNCTION button on the remote control (see page 63).

• TIME OUT (5 MIN)

Set the marker display time-out.

ON: The marker display disappears in 5 minutes (time out).

OFF: The marker display time-out does not occur.

Marker advanced settings

• 16 : 9

Select 16:9 marker display and the marker type.

OFF ↔ 4:3(1.33) ↔ 13:9(1.44) ↔ 14:9(1.55) ↔ CNSCO(2.39) ↔ VISTA(1.85) ↔ 95% ↔ 93% ↔ 90% ↔ 88% ↔ 80% ↔ USER

- This setting is valid only if an aspect of “FULL” is used.

Aspect marker

4:3, 13:9, 14:9, CNSCO, VISTA



4:3 marker



CNSCO marker (2.39:1)



VISTA marker (1.85:1)

Safe area marker

95%, 93%, 90%, 88%, 80%, USER

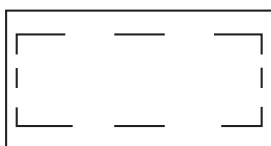

90% Area marker

- Selecting USER allows the marker area set in 1% increments in “MARKER SIZE (%)” to be reflected in the configuration of safe area marker.

• 4 : 3

Select 4:3 marker display and the safe area marker type.

OFF ↔ 95% ↔ 93% ↔ 90% ↔ 88% ↔ 80% ↔ USER

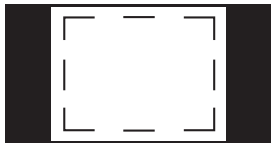

90% Area marker

- Selecting USER allows the marker area set in 1% increments in "MARKER SIZE (%)" to be reflected in the configuration of safe area marker.

• CENTER

The center marker is displayed.

OFF ↔ ON

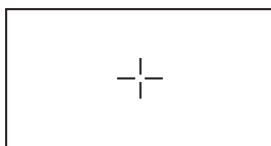

• CROSS HATCH

The markers at regular vertical and horizontal intervals are displayed.

OFF ↔ ON

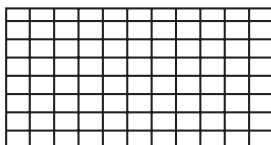

• MARKER SIZE(%)

User setting for the marker area can be configured.

80% - 100%

This setting is valid for the selection of "USER" in "16:9" or "4:3".

• BRIGHTNESS

Brightness is set for each marker.

1 - 5

• COLOR

Color is set for each marker.

RED ↔ GREEN ↔ BLUE ↔ YELLOW ↔ CYAN ↔ MAGENTA ↔ GRAY

Note:

Several markers can be displayed at once.

(Example)

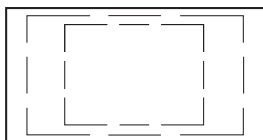

16:9 marker: 95% safe area marker

4:3 marker: 80% safe area marker

SETUP menu

RGB/MONO SETTINGS

Turn off R, G, B signals to adjust the image.

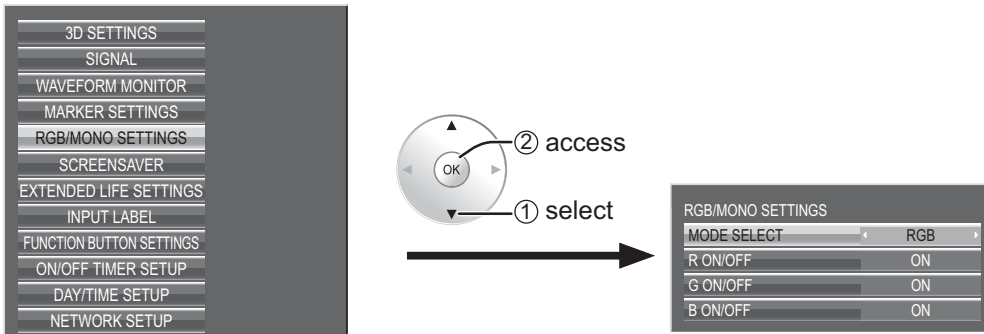

1 Select mode by "MODE SELECT".

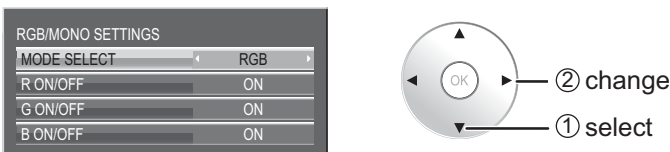

RGB: Displays with one of red, green and blue signals cut.

BLUE ONLY: Displays in solid blue.

MONO: Only Y signal is used for black and white displays.

2 Configure each mode setting.

For RGB mode

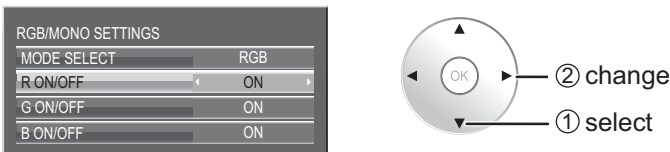

• R ON/OFF, G ON/OFF, B ON/OFF

OFF ↔ ON

ON: The red (for "R ON/OFF"), green (for "G ON/OFF") or blue (for "B ON/OFF") signal is on.

OFF: The red (for "R ON/OFF"), green (for "G ON/OFF") or blue (for "B ON/OFF") signal is cut.

For BLUE ONLY mode

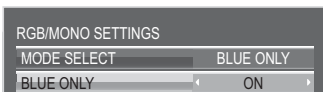

• BLUE ONLY

OFF ↔ ON

ON: The BLUE ONLY mode is enabled.

OFF: The BLUE ONLY mode is disabled

For MONO mode

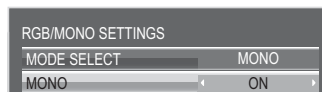

• MONO

OFF ↔ ON

ON: The MONO mode is enabled.

OFF: The MONO mode is disabled

The RGB/MONO SETTINGS function is also enabled/disabled with the FUNCTION button on the remote control (see page 63).

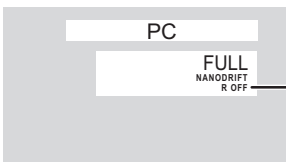

When the function is enabled, selected mode is displayed.

Note:

With MONO set, the color adjustment in the PICTURE menu is not available.

When the setting of each item is enabled, the item being currently set to 'Enable' becomes disabled.

SCREENSAVER

Do not display a still picture, especially in 4:3 mode, for any length of time.
If the display must remain on, a SCREENSAVER should be used.

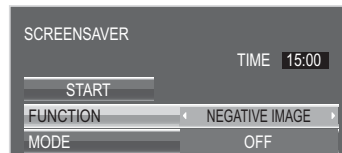
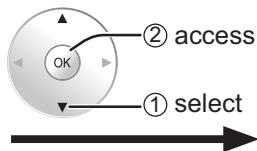
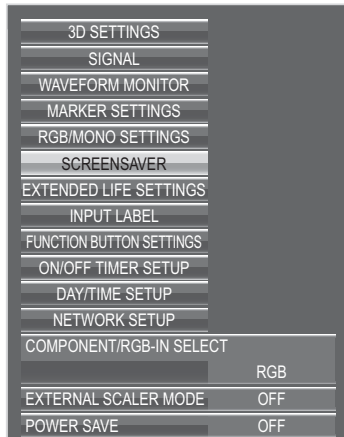

1 FUNCTION selection

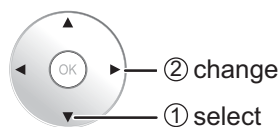
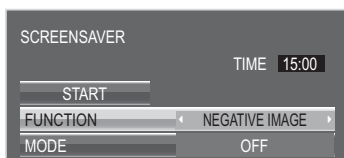

NEGATIVE IMAGE: A negative image will be displayed on the screen.

SCROLLING BAR ONLY: A white bar will scroll from left to right. The image won't be displayed.

OVERLAY SCROLLING BAR: The brightness of the image will be decreased and a white bar will scroll on it.

WHITE SCREEN: The whole screen will be white.

2 MODE selection

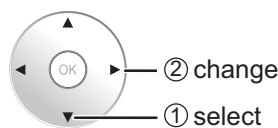
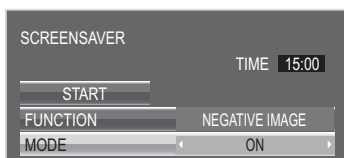

OFF

INTERVAL: Operates when SHOW DURATION and SAVER DURATION are set up and those times arrive.

TIME OF DAY: Operates when START TIME and FINISH TIME are set up and those times arrive.

STANDBY AFTER SCR SAVER: Operates while SCREENSAVER DURATION, and display enters standby mode.

ON: Operates when START is selected and the OK button is pressed.

SETUP menu

3 Setup of SCREENSAVER Time

After selecting TIME OF DAY, INTERVAL or STANDBY AFTER SCR SAVER, the relevant Time Setup will become available for selection and the Operating Time may be set. (Time cannot be set when "MODE" is "ON" or "OFF".)

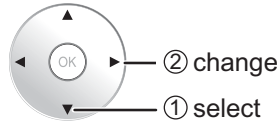
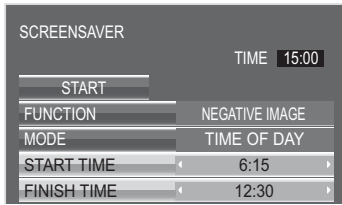

Notes:

- Pressing "◀" or "▶" button once changes the Time 1 minute. [However, switching occurs every 15 minutes when Periodic Time is selected.]
- Pressing "◀" or "▶" button continuously changes the Time by 15 minutes.
- "SCREENSAVER DURATION" of the "STANDBY AFTER SCR SAVER" can be set from 0:00 to 23:59. When this is set to "0:00", "STANDBY AFTER SCR SAVER" will not be activated.

Note: Timer function will not work unless "DAY/TIME SETUP" is set.

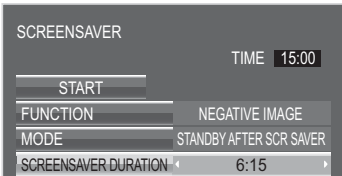
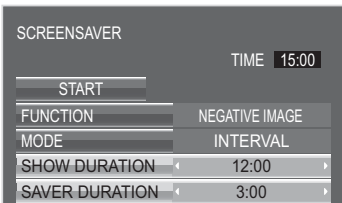

4 START setting

Select "START".

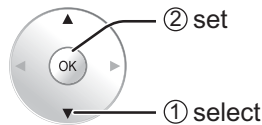
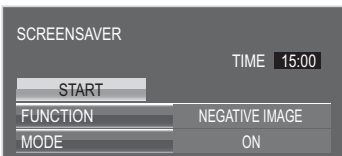

The menu screen will disappear and the SCREENSAVER will be activated.
To stop the SCREENSAVER under ON, press the R button or any buttons on the main unit.

Note: When the display is turned off, the SCREENSAVER will be deactivated.

EXTENDED LIFE SETTINGS

The following settings are setup to reduce image retention:

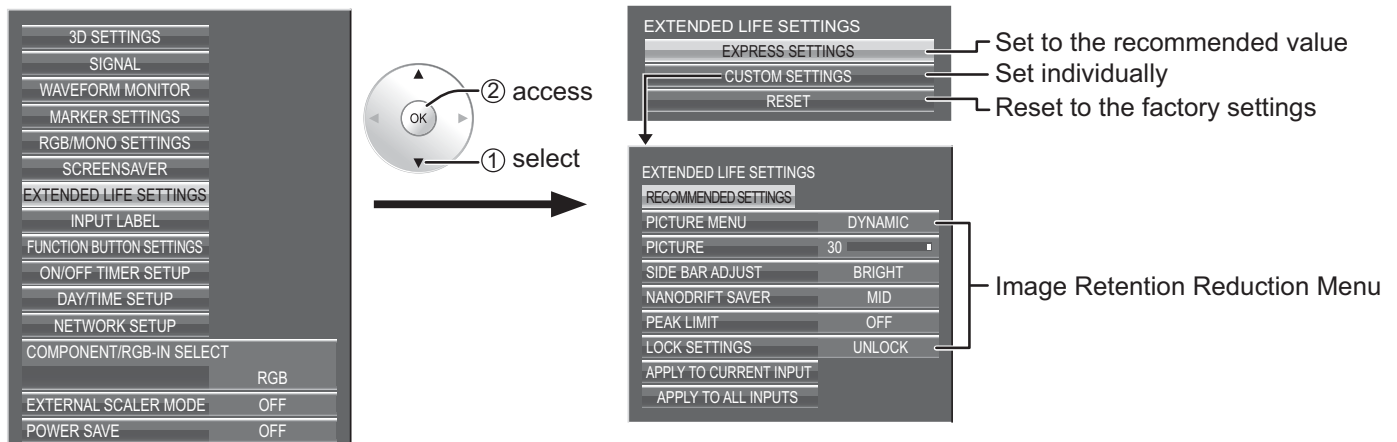

Image Retention Reduction Menu

“EXTENDED LIFE SETTINGS” enables you to set the following 5 menus (Image Retention Reduction Menu) as recommended values or set them individually.

PICTURE MENU

PICTURE

“PICTURE MENU” and “PICTURE” are same as “PICTURE” menu items (see page 30). The settings of this menu will be reflected to the “PICTURE” menu.

SIDE BAR ADJUST

Do not display a picture in 4:3 mode for an extended period, as this can cause an image retention to remain on the side bars on either side of the display field.

To reduce the risk of such an image retention, illuminate the side bars.

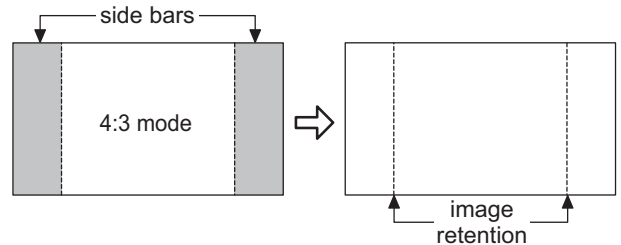

This function may be applicable to the non-picture area.

- OFF:** Darken both ends.
- DARK:** Make it dark gray.
- MID:** Make it gray.
- BRIGHT:** Make it light gray.

Notes:

- To reduce the occurrence of image retention, set the SIDE BAR ADJUST to BRIGHT.
- The side bar may flash (alternate black/white) depending on the picture being shown on the screen. Using Cinema mode will reduce such flashing.

SETUP menu

NANODRIFT SAVER

Moves the display position of the screen slightly to reduce image retention on the display panel.

LOW-HIGH: NANODRIFT SAVER operates. The display position of the screen moves at set time intervals. You can set the screen movement range. Some of the screen may appear to be missing as a result of this operation. If you change the value, a mask is displayed in the range where the picture is missing as a result of position movement.



When "NANODRIFT" Image Retention Reduction is operating, "NANODRIFT" is displayed.

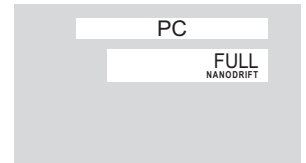

PEAK LIMIT

ON: Suppresses image contrast (peak brightness).

Note: When a still picture is viewed for an extended time, the screen may become slightly darker. (see page 70)

EXPRESS SETTINGS

Set the "Image Retention Reduction" menu to the recommended settings.

All menus will be locked.

PICTURE MENU: CINEMA

PICTURE: Recommended setting for each model

SIDE BAR ADJUST: BRIGHT

NANODRIFT SAVER: MID

PEAK LIMIT: ON

1 Select "EXPRESS SETTINGS".

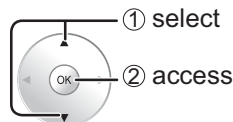
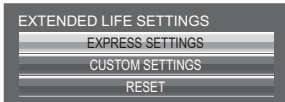

2 Select the input to apply the settings.

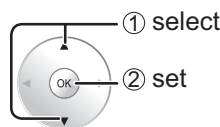
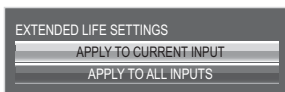

3 Select "YES".

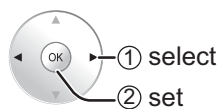
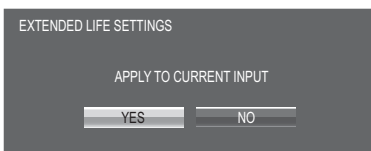

CUSTOM SETTINGS

Set the individual "Image Retention Reduction" menu.

1 Select "CUSTOM SETTINGS".

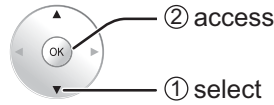

When a menu is locked, it is grayed out and cannot be set. "PICTURE MENU" and "PICTURE" will no longer be able to set in the "PICTURE" menu, and they are labeled with icon to indicate their locked status. Also, "NORMALIZE", "MEMORY SAVE" and "MEMORY LOAD" are not available.

2 To set each menu to the recommended setting: Select "RECOMMENDED SETTINGS".

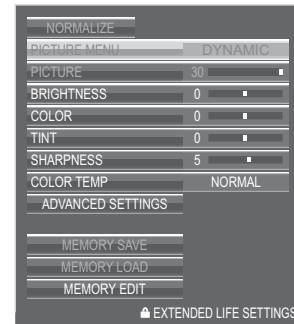
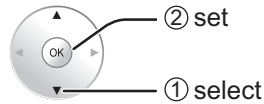
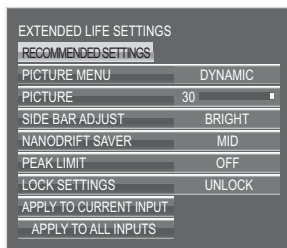

Each menu will be set as same as the "EXPRESS SETTINGS".

3 Set each menu.

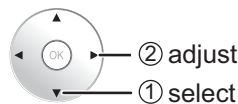
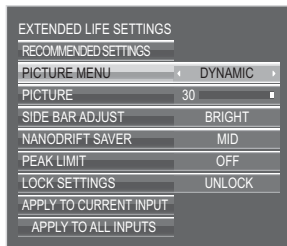

5 Select the input to apply the settings.

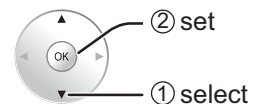
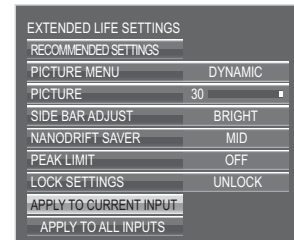

4 To lock each menu setting: Set the "LOCK SETTINGS" to "LOCK".

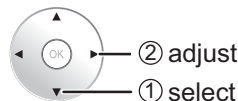
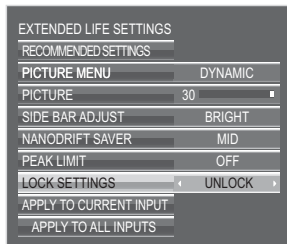

6 Select "YES".

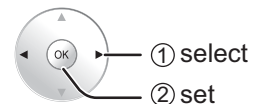
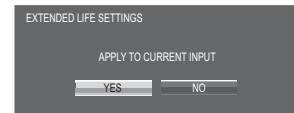

RESET

Reset the "Image Retention Reduction" menu to the factory settings. Each menu will be unlocked.

1 Select "RESET".

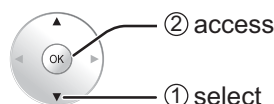

3 Select "YES".

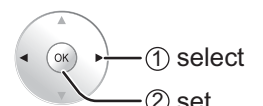
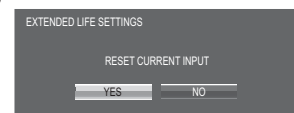

2 Select the input to reset the settings.

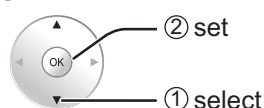
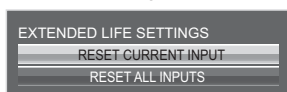

SETUP menu

Customizing the Input labels

This function can change the label of the Input signal to be displayed. (see page 18)

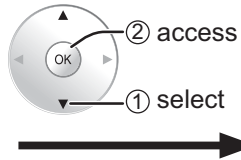
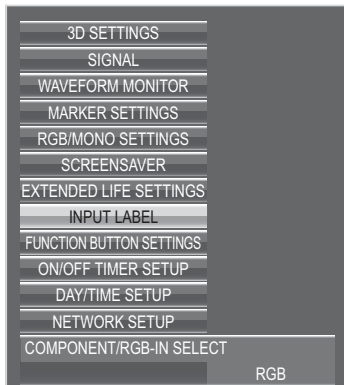

Select an input terminal and set.

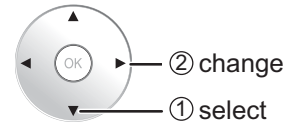
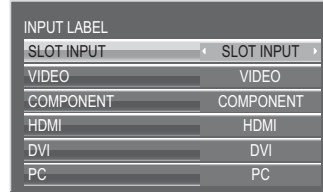

Note:

The setting items are the same as the input terminal list of "Selecting the input signal" (page 18).

The input label changes as follows each time the ◀ or ▶ button is pressed.

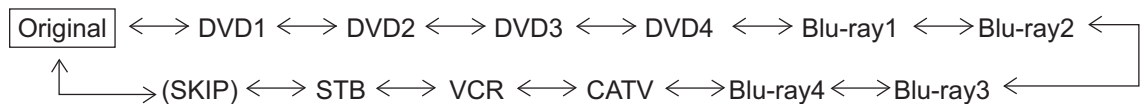

(SKIP) : The INPUT button press will skip its input.

FUNCTION BUTTON SETTINGS

Set the function to operate when the FUNCTION button 1 to 8 on the remote control is pressed.

Using **FUNCTION button** → page 63

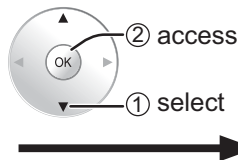
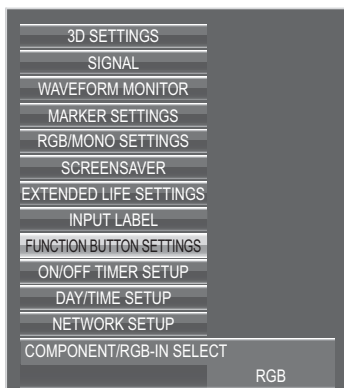

Select the item and set.

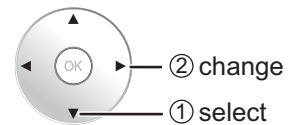
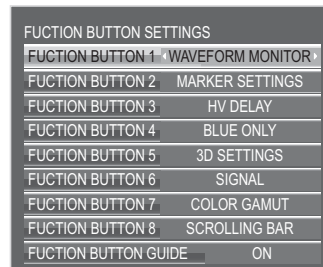

Note:

The button functions are configured in two ways depending on the setting (On/Off) of "Studio mode" in the OPTIONS menu.

• FUNCTION BUTTON 1 – FUNCTION BUTTON 8

The following functions are set to the FUNCTION button.

WAVEFORM MONITOR*	B ON/OFF
MARKER SETTINGS*	MONO
HV DELAY*	TEST PATTERNS
BLUE ONLY	DIGITAL ZOOM
3D SETTINGS	OFF TIMER
SIGNAL	EXTERNAL SCALER MODE
COLOR GAMUT	VOLUME +
SCROLLING BAR	VOLUME -
R ON/OFF	MUTE
G ON/OFF	

* "WAVEFORM MONITOR", "MARKER SETTING" and "HV DELAY" can be set when "Studio mode" in OPTIONS menu is "On".

• FUNCTION BUTTON GUIDE

The function display setting for the FUNCTION button is configured.

ON: Press the FUNCTION button to display the function list of the button.

OFF: The function list is not displayed.

DAY/TIME SETUP / ON/OFF TIMER SETUP

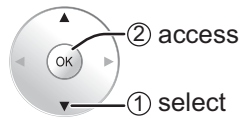
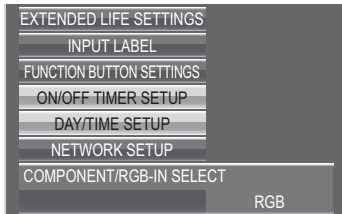

DAY/TIME SETUP

- 1**
- Press to select DAY or TIME.
 - Press to set up DAY or TIME.
 ▶ button: Forward
 ◀ button: Back

- Notes:**
- Pressing “◀” or “▶” button once changes TIME 1 minute.
 - Pressing “◀” or “▶” button continuously changes TIME by 15 minutes.

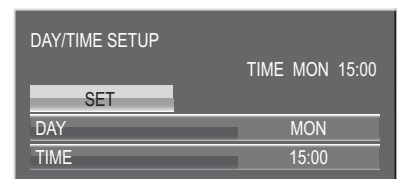

- 2**
- Press to select SET.
 - Press to store DAY/TIME SETUP.

- Notes:**
- SET cannot be selected unless TIME is set.
 - Unless setting the present time other than “99:99”, “DAY” and “TIME” cannot be set.
 - The settings of “DAY” and “TIME” are reset when leaving the display turned off for about 7 days for the following reasons:
 Pressing ⏻/⏺ switch of the unit to turn off the display.
 Disconnecting the AC cord.
 Interruption of power supply.

ON/OFF TIMER SETUP

- 1**
- Press to select POWER ON TIME / POWER OFF TIME.
 - Press to set up POWER ON TIME / POWER OFF TIME.
 ▶ button: Forward
 ◀ button: Back

- Notes:**
- Pressing “◀” or “▶” button once changes POWER ON TIME / POWER OFF TIME 1 minute.
 - Pressing “◀” or “▶” button continuously changes POWER ON TIME / POWER OFF TIME by 15 minutes.

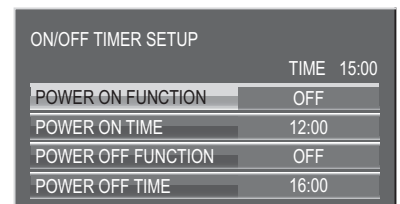

- 2**
- Press to select POWER ON FUNCTION / POWER OFF FUNCTION.
 - Press to select ON.
- Note:**
 Timer function will not work unless “TIME” is set.

Network Setup

Make the various settings to use the network function.

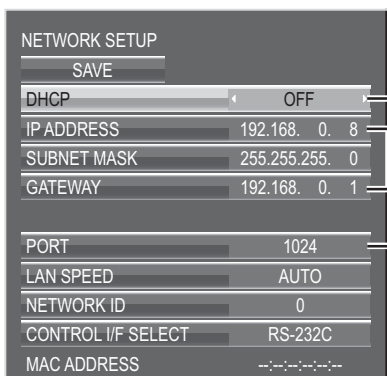
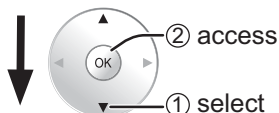
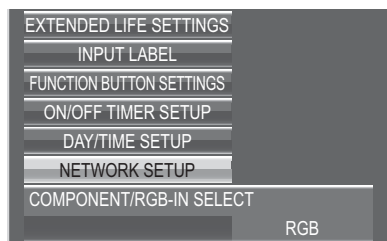

DHCP, IP ADDRESS, SUBNET MASK, and GATEWAY settings

1 Set DHCP.
When "OFF" is selected, IP ADDRESS and other settings can be set manually.

2 Select the item and press **OK**.

3 Enter an address.

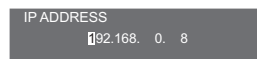

① Use **◀▶** to select a digit.

② Use **▲▼** to change a number or input the numerical value from **0** to **9**.

③ Press **OK**.

Pressing **RETURN** will cancel the address change.

4 Select "SAVE" and press **OK**.

PORT setting

1 Select "PORT" and press **OK**.

2 Enter a port number.

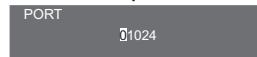

① Use **◀▶** to select a digit.

② Use **▲▼** to change a number or input the numerical value from **0** to **9**.

③ Press **OK**.

Pressing **RETURN** will cancel the port number change.

SAVE

Save the current network Setup. Each value set for DHCP, IP address, Subnet mask, and Gateway will be saved. If "NG" is displayed, check the same IP address is not used within the same network.

DHCP (DHCP client function)

To obtain an IP address automatically using a DHCP server, set this to "ON". If DHCP server is not used, set this to "OFF".

IP ADDRESS (IP address display and setting)

Enter an IP address if DHCP server is not used.

SUBNET MASK (Subnet mask display and setting)

Enter a subnet mask if DHCP server is not used.

GATEWAY (Gateway address display and setting)

Enter a gateway address if DHCP server is not used.

Notes:

- To use a DHCP server, make sure the DHCP server is started.
- Contact your network administrator for details on settings.

PORT

Set the port number used for command control.

The available setting range is 1024 – 65535.

When the PJLink™ protocol is used, the port setting is not necessary.

LAN SPEED

Set the connection speed of the LAN environment.

Select the value from AUTO, 10 HALF, 10 FULL, 100 HALF or 100 FULL.

NETWORK ID

Set the ID to identify this unit.

The available setting range is 0 – 99.

CONTROL I/F SELECT

Set whether to control with RS-232C (serial) or LAN. When "LAN" is set, the slot power is turned on, and power indicator is lit orange under the condition of power off with remote control (stand-by state), regardless of the "Slot power" setting. (see page 60)

MAC ADDRESS

Display the MAC address of this unit. However, the MAC address is not displayed when the "CONTROL I/F SELECT" is set to "RS-232C".

OPTIONS Adjustments

1 Display the menu screen.



2 Select "OPTIONS".

3 Press **OK** for more than 3 seconds.

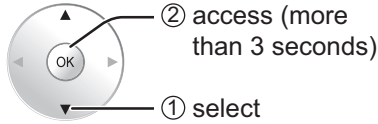

4 Select the item and set.

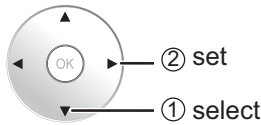
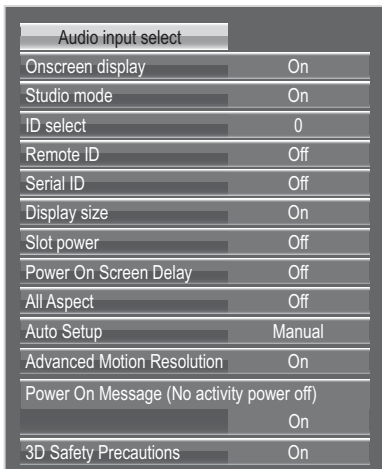







5 Exit the menu.



Item	Adjustments			
Audio input select	Set up the sound when an image input is selected. (see page 62)			
Onscreen display	<p>On: Displays all the following on screen.</p> <ul style="list-style-type: none"> Power on display Input signal switch display No signal display Remaining time of off-timer after RECALL was pressed. <p>Off: Hides all the items above from view.</p>			
Studio mode	For switching functions in setting menus used for television studio applications.			
	Setting menu		Studio mode: On	Studio mode: Off
	PICTURE	COLOR TEMP	"STUDIO" can be selected.	"STUDIO" not available.
	ADVANCED	STUDIO GAIN	Available	Unavailable (set to "OFF" and cannot be changed).
	SETUP	WAVEFORM MONITOR	Available	Unavailable
		MARKER SETTINGS	Available	Unavailable
		3D COLOR COMPENSATION	Available	Unavailable
	FUNCTION BUTTON SETTINGS	The button functions are separately configured in "On" and "Off".		
	WAVEFORM MONITOR MARKER SETTINGS HV DELAY	Configurable.	Not configurable.	
POS./SIZE	HV DELAY	Available	Unavailable	

OPTIONS Adjustments

Item	Adjustments
ID select	Sets panel ID number when panel is used in "Remote ID" or "Serial ID". Set value range: 0 - 100 (Standard value: 0)
Remote ID	The setting of this menu is valid only when using ID remote control. Off: Disables ID remote control functions. You can use normal remote control operations. On: Enable ID remote control functions. Note: To use the ID remote control function, it is necessary to set each ID number of remote control and display unit. About the setting method, please refer to "ID Remote Control Function" (see page 73) and "ID select" (above-mentioned).
Serial ID	Sets the panel ID Control. Off: Disables external control by the ID. On: Enables the external control by the ID.
Display size	Adjusts the image display size on screen. Off: Sets the normal image display size on screen. On: Sets the image display size approximately 95 % of the normal image display. <div style="display: flex; justify-content: space-around; align-items: center;"> <div style="text-align: center;"> <p>Off</p>  </div> <div style="text-align: center;"> <p>On</p>  </div> </div> <p>Notes:</p> <ul style="list-style-type: none"> This setting is valid only when the input signals are as follows; NTSC, PAL, SECAM, M.NTSC, PAL60, PAL-M, PAL-N (Video) 525i, 525p, 625i, 625p, 750/60p, 750/50p, 1125/60i, 1125/50i, 1125/24sF, 1125/25p, 1125/24p, 1125/30p, 1125/60p, 1125/50p, 1250/50i (Component Video, RGB, DVI, SDI, HDMI) This setting is invalid when digital zoom is selected. When "Display size" is set to "On", "H-POS" and "V-POS" in "POS./SIZE" can be adjusted. Refer to each board's operating instruction for DVI, SDI, HDMI's corresponding signals.
Slot power	Off ↔ Auto ↔ On Off: Power is not transmitted to the slot power. Auto: Power is transmitted to the slot power only when main power is on. On: Power is transmitted to the slot power when main power is on or in the standby state. Note: In some cases, power is transmitted to the slot power when main power is on or in the standby state regardless of the slot power setting.
Power On Screen Delay	Off ↔ 1 ↔ 2 ↔ 3... ↔ 30 You can set the power-on delay time of the displays to reduce the power load, when you press  / to turn on the multiple displays that are set together. Set each display's setting individually. Off: The display will be turned on at the same time as  / is pressed. 1 to 30 (sec.): Set the power-on delay time (second). After pressing  / , the display will be powered on with time delay depending on this setting. Notes:
All Aspect	Sets All Aspect mode (advanced aspect setting) or default aspect mode. With each press of  button, the aspect changes in the selected mode. Off: Default aspect mode On: All Aspect mode Aspect mode of each setting is as follows: (Example: HD signal) Off 4:3→H-FILL→ZOOM→FULL→JUST On 4:3 (1)→4:3 (2)→4:3 Full→Zoom1→Zoom2→Zoom3→16:9→14:9→Just1→Just2

OPTIONS Adjustments

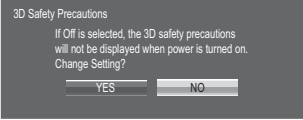
Item	Adjustments
Auto Setup	<p>Sets the operational mode of the automatic position adjustment in the POS./SIZE menu.</p> <p>Manual: Automatic position adjustment starts when  is pressed on the remote control or automatic position adjustment is executed from the POS./SIZE menu.</p> <p>Auto: Other than remote control or menu operation, automatic position adjustment starts: When the display power is turned ON. When the input signal is switched.</p>
Advanced Motion Resolution	<p>Displays motion picture images at higher resolution.</p> <p>On \longleftrightarrow Off</p> <p>Notes:</p> <ul style="list-style-type: none"> • Please set to “Off” if images look unnatural. • This function is disabled during 3D images.
Power On Message (No activity power off)	<p>Whether to show/hide No activity power off Precautions at the time of power ON is set.</p> <p>On: The warning precautions are shown at the time of power ON.</p> <p>Off: The warning precautions are not shown at the time of power ON.</p> <p>Note: This setting is enabled only if “NO ACTIVITY POWER OFF” is “ENABLE” (see page 42).</p>
3D Safety Precautions	<p>3D Safety Precautions show/hide is set during power ON.</p> <p>On: 3D Safety Precaution is shown every time when the power is ON.</p> <p>Off: 3D Safety Precaution is not shown when the power is ON.</p> <p>When the setting changes from “On” to “Off”, the confirmation screen is displayed as below. Pressing “YES” switches the setting.</p> <div style="text-align: center; margin-top: 10px;">  <p>The image shows a dark grey dialog box with the following text: '3D Safety Precautions', 'If Off is selected, the 3D safety precautions will not be displayed when power is turned on.', 'Change Setting?', and two buttons labeled 'YES' and 'NO'.</p> </div>

OPTIONS Adjustments

Audio input select

Set up the sound when an image input is selected.

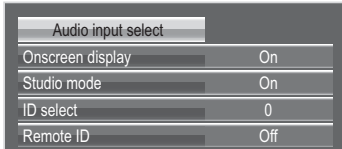

↓ Press button

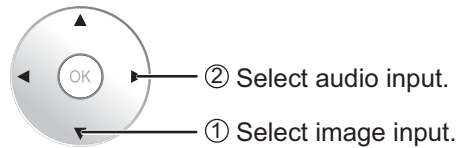
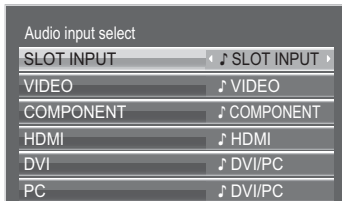

Image input	Audio input
[SLOT INPUT]*1	SLOT INPUT / VIDEO / COMPONENT / DVI/PC / NO AUDIO
[VIDEO]	SLOT INPUT / VIDEO / COMPONENT / DVI/PC / NO AUDIO
[COMPONENT]*2	SLOT INPUT / VIDEO / COMPONENT / DVI/PC / NO AUDIO
[HDMI]	SLOT INPUT / VIDEO / COMPONENT / HDMI / DVI/PC / NO AUDIO
[DVI]	SLOT INPUT / VIDEO / COMPONENT / DVI/PC / NO AUDIO
[PC]	SLOT INPUT / VIDEO / COMPONENT / DVI/PC / NO AUDIO

DVI/PC: Sound input for both DVI and PC.

NO AUDIO: No audio input (Mute)

*1 "SLOT INPUT" is displayed when a Terminal Board is installed.

*2 "COMPONENT" may be displayed as "RGB" depending on the setting of "COMPONENT/RGB-IN SELECT".
(see page 40)

When a Terminal Board with dual input terminals is installed

"SLOT INPUT" is displayed as "SLOT INPUT A" and "SLOT INPUT B" and independent settings are available. To set other image inputs, you can select "SLOT INPUT A" and "SLOT INPUT B".

Image input	Audio input
[SLOT INPUT A]	SLOT INPUT A / VIDEO / COMPONENT / DVI/PC / NO AUDIO
[SLOT INPUT B]	SLOT INPUT B / VIDEO / COMPONENT / DVI/PC / NO AUDIO
[VIDEO]	SLOT INPUT A / SLOT INPUT B / VIDEO / COMPONENT / DVI/PC / NO AUDIO
[COMPONENT]	SLOT INPUT A / SLOT INPUT B / VIDEO / COMPONENT / DVI/PC / NO AUDIO
[HDMI]	SLOT INPUT A / SLOT INPUT B / VIDEO / COMPONENT / HDMI / DVI/PC / NO AUDIO
[DVI]	SLOT INPUT A / SLOT INPUT B / VIDEO / COMPONENT / DVI/PC / NO AUDIO
[PC]	SLOT INPUT A / SLOT INPUT B / VIDEO / COMPONENT / DVI/PC / NO AUDIO

When Image input and Audio input differ from each other, the Audio input is displayed as below.

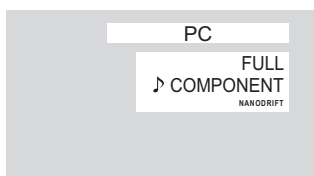

Notes:

- HDMI Audio is selectable only for HDMI input.
- You cannot set audio of B for SLOT INPUT A, or audio of A for SLOT INPUT B.

Using FUNCTION button

Assigning functions to the FUNCTION button on the remote control enables a user to switch between show/hide and modes with just a single touch of a button. The function settings are configured by using "FUNCTION BUTTON SETTINGS" in the SETUP menu (see page 56). The button functions are configured in two ways depending on the setting (On/Off) of "Studio mode" in the OPTIONS menu. Similarly, factory default settings vary as follows.

Factory default settings

	Studio mode: On	Studio mode: Off
FUNCTION Button 1	WAVEFORM MONITOR	OFF TIMER
FUNCTION Button 2	MARKER SETTINGS	EXTERNAL SCALER MODE
FUNCTION Button 3	HV DELAY	TEST PATTERNS
FUNCTION Button 4	BLUE ONLY	BLUE ONLY
FUNCTION Button 5	3D SETTINGS	3D SETTINGS
FUNCTION Button 6	SIGNAL	SIGNAL
FUNCTION Button 7	COLOR GAMUT	COLOR GAMUT
FUNCTION Button 8	SCROLLING BAR	SCROLLING BAR

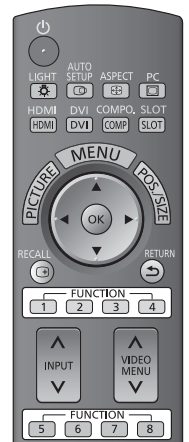

Display of the FUNCTION button guide

Pressing the FUNCTION button can display the FUNCTION button guide to refer for the function of each button.

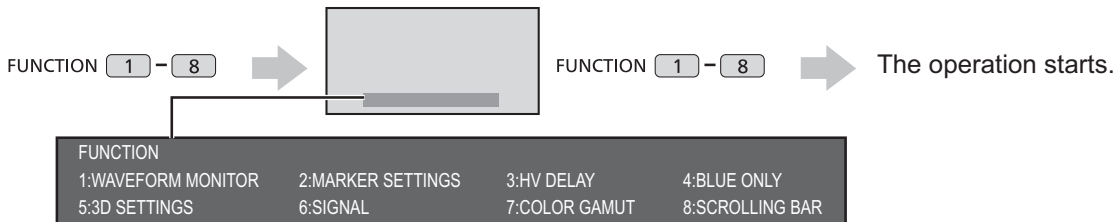

If the guide display is not needed, set "FUNCTION BUTTON GUIDE" in "FUNCTION BUTTON SETTINGS" to "OFF" (see page 56).

3D SETTINGS / SIGNAL / COLOUR GAMUT

Menu is displayed.
(Example: 3D SETTINGS)

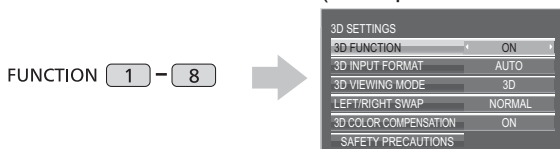

Pressing the FUNCTION button clears the menu.

SCROLLING BAR / TEST PATTERNS

Confirmation screen (Example: SCROLLING BAR)



• SCROLLING BAR

Activates the SCROLLING BAR ONLY screensaver. After 15 minutes, the display enters standby mode.



To exit this mode, press any button.

• TEST PATTERNS

Each time you press , a different test pattern is displayed (seven in all).

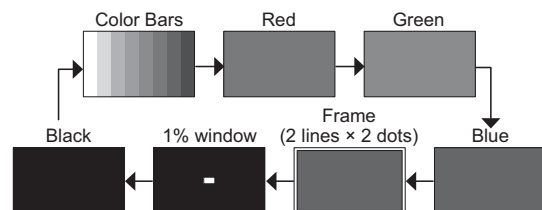

To exit this mode, press any button other than .

Note:

PC POWER MANAGEMENT, DVI-D POWER MANAGEMENT and NO SIGNAL POWER OFF are deactivated during SCROLLING BAR or TEST PATTERNS operation. (see page 42)

Using FUNCTION button

WAVEFORM MONITOR

The waveform monitor displays (see page 47).
To exit this mode, press the FUNCTION button.

MARKER SETTINGS

The marker displays (see page 48).
Each time the FUNCTION button is pressed, the screen is switched in the following order;
PRESET1 → PRESET2 → OFF.

HV DELAY

The video blanking period displays (see page 28).
Each time the FUNCTION button is pressed, the screen is switched in the following order;
H DELAY → V DELAY → HV DELAY → OFF.

BLUE ONLY

The screen displays only blue color for image adjustment.
To exit this mode, press FUNCTION button.

MONO

The screen is displayed in black and white by the Y signal alone (see page 50).
To cancel, press the FUNCTION button.

R ON/OFF / G ON/OFF / B ON/OFF

R / G / B signals are turned off (see page 50).
Each time the FUNCTION button is pressed, each signal switches between On/Off.

DIGITAL ZOOM

The digital zoom function starts up (see page 22).
To exit this mode, press the FUNCTION button.

OFF TIMER

The Plasma Display can be preset to switch to stand-by after a fixed period.
The setting changes to 30 minutes, 60 minutes, 90 minutes and 0 minutes (off timer cancelled) each time the FUNCTION button is pressed.

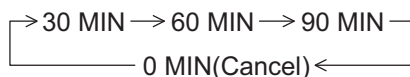

When three minutes remain, "OFF TIMER 3 MIN" will flash.
The off timer is cancelled if a power interruption occurs.

EXTERNAL SCALER MODE

The scaler function is set (see page 41).
Each time the FUNCTION button is pressed, it switches between ON/OFF.

VOLUME + / VOLUME -

The volume is adjusted.
Press the FUNCTION button to turn the volume UP/DOWN.

MUTE

The sound is temporarily muted.
Press the FUNCTION button again to cancel.

Using Network Function

This unit has a network function to control the network connected display with your computer.

Note:

To use the network function, set each "NETWORK SETUP" setting and make sure to set the "CONTROL I/F SELECT" to "LAN". (see page 58)

When "LAN" is set, the slot power is turned on, and power indicator is lit orange under the condition of power off with remote control (stand-by state), regardless of the "Slot power" setting. (see page 60)

Example of Network Connection

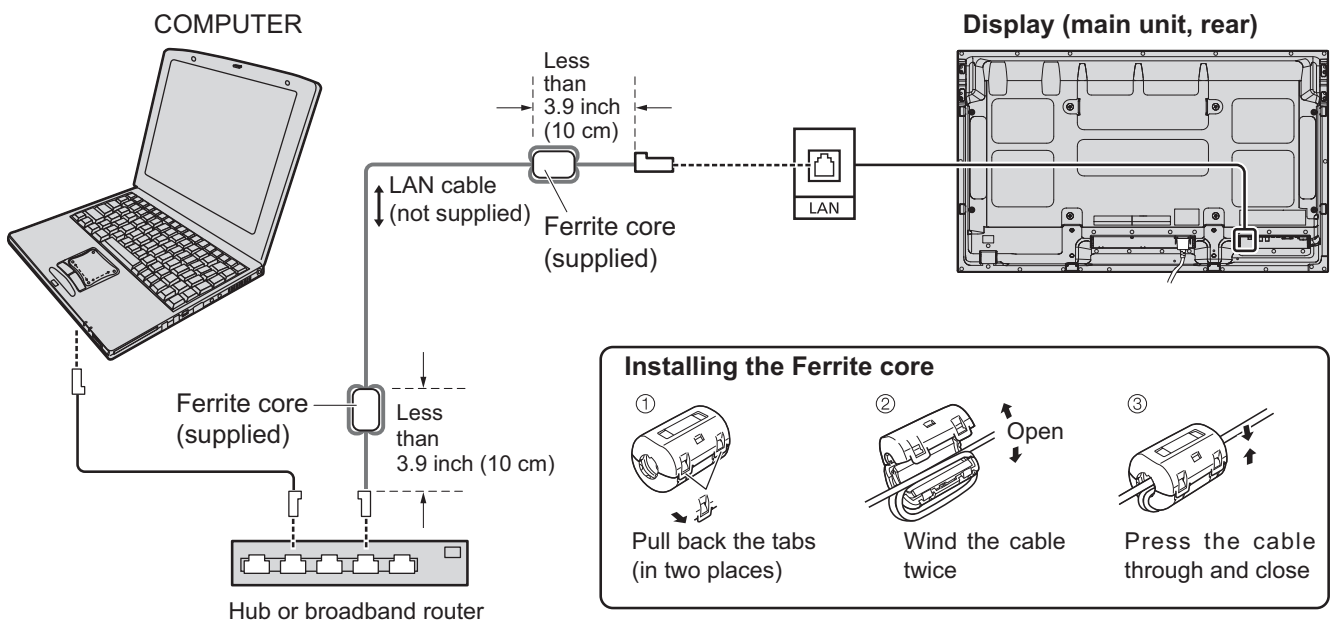

Notes:

- Make sure the broadband router or hub supports 10BASE-T/100BASE-TX.
- To connect a device using 100BASE-TX, use "category 5" LAN cable.
- Touching the LAN terminal with a statically charged hand (body) may cause damage due to its discharge. Do not touch the LAN terminal or a metal part of the LAN cable.
- For instructions on how to connect, consult your network administrator.

Command Control

Network function of the unit can control the unit in the same way as serial control from a network.

Supported commands

Commands used in the serial control are supported. (see page 15)

Note:

Consult your local Panasonic dealer for detail instructions on command usage.

Using Network Function

PJLink™ Protocol

The network function of the unit conforms with PJLink™ class 1 and you can operate the following actions from your computer using PJLink™ protocol.

- Display setup
- Display status query

Supported commands

Commands to control the unit with PJLink™ protocol are shown in the table below.

Command	Control	Remark
POWR	Power control	Parameter 0 = Standby 1 = Power "On"
POWR?	Power status query	Parameter 0 = Standby 1 = Power "On"
INPT	Input switch	Parameter
INPT?	Input switch query	See the parameter for command INST?
AVMT	Shutter control	Parameter 10 = Picture On (picture mute deactivated), 11 = Picture Off (picture on mute) 20 = Audio On (audio mute deactivated), 21 = Audio Off (audio on mute) 30 = Shutter mode Off (picture and audio mute deactivated) 31 = Shutter mode On (picture and audio on mute)
AVMT?	Shutter control query	Parameter 11 = Picture Off (picture on mute) 21 = Audio Off (audio on mute) 30 = Shutter mode Off (picture and audio mute deactivated) 31 = Shutter mode On (picture and audio on mute)
ERST?	Error status query	Parameter First byte: Means fan error. 0 or 2. Second byte: 0 Third byte: 0 Fourth byte: 0 Fifth byte: 0 Sixth byte: Means other error. 0 or 2. Meaning of the 0 – 2 settings: 0 = Error is not detected, 2 = Error
LAMP?	Lamp status query	Not supported
INST?	Input switch list query	Parameter Numbers 11 to 13 are depending on the slot installation condition 11: PC IN input (PC) When a single input terminal board is attached 11: SLOT input (SLOT INPUT) 12: PC IN input (PC) When a dual input terminal board is attached 11: SLOT input (SLOT INPUT A) 12: SLOT input (SLOT INPUT B) 13: PC IN input (PC) 21: VIDEO input (VIDEO) 31: HDMI input (HDMI) 22: COMPONENT/RGB IN input (COMPONENT) 32: DVI-D IN input (DVI)
NAME?	Projector name query	Returns empty character (no name information)
INF1?	Manufacturer name query	Returns "Panasonic"
INF2?	Model name query	Returns "TH-50BT300" (for 50-inch model)
INFO?	Other information query	Returns version number
CLSS?	Class information query	Returns "1"

PJLink™ security authentication

Set "Panasonic" for the PJLink™ password.

- PJLink™ is a pending trademark in Japan, the United States, and other countries or areas.

Using Web Browser Control

You can use a Web browser to control the unit and set up a network and password.

Before Using Web Browser Control

To use the Web browser control, the unit and computer setups are required.

Unit Setup

Set each "NETWORK SETUP" setting and make sure to set the "CONTROL I/F SELECT" to "LAN". (see page 58)

Computer Setup

Disable the proxy server settings and enable JavaScript.

(Windows)

Disable proxy server settings

- 1 Display [Internet Properties] window.
Click [Start] – [Control Panel] – [Network and Internet Connections] – [Internet Options].
- 2 Click the [Connections] tab and then [LAN Settings].
- 3 Deselect the [Use automatic configuration script] and [Use a proxy server for your LAN] boxes.
- 4 Click [OK].

Enable JavaScript

- 1 Display [Internet Properties] window.
Click [Start] – [Control Panel] – [Network and Internet Connections] – [Internet Options].
- 2 Set the security level on the [Security] tab to [Default Level]. Alternatively enable [Active scripting] from the [Custom Level] button.

(Macintosh)

Disable proxy server settings

- 1 From the [Safari] menu, click [Preferences].
General screen is displayed.
- 2 From the [Advanced] tab, click the [Change Settings...] button next to [Proxies]. Click [Proxies] and set up a proxy server.
- 3 Deselect the [Web Proxy] and [Automatic Proxy Configuration] boxes.
- 4 Click [Apply Now].

Enable JavaScript

- 1 Display [Security] of Safari.
- 2 Select [Enable JavaScript] under [Web content].

Access from Web Browser

Access to the TOP screen of the Web browser control using a Web browser.

- 1 Start your Web browser.
- 2 Enter the IP address set with the "NETWORK SETUP" of the unit. (see page 58)

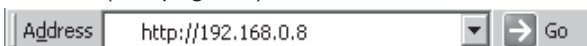

- 3 Enter the user name and password when the Authentication screen is displayed.

Authentication screen

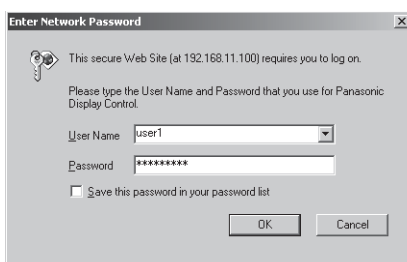

- 4 Click [OK].
After logged in, the TOP screen of the Web browser control is displayed. (see page 68)

Notes:

- The password used here is the same password used for command control and the PJLink™ security authentication.
- Default user name and password are as follows:
User name: user1
Password: Panasonic
- The password can be changed on the Password Setup screen after logging in (see page 69). The user name cannot be changed.
- Under no circumstances, Panasonic Corporation or its associated companies will ask customers their password directly.
Even if you are asked directly, please do not reveal your password.

Using Web Browser Control

TOP screen structure of the Web browser control

After logging in, the TOP screen of the Web browser control is displayed.

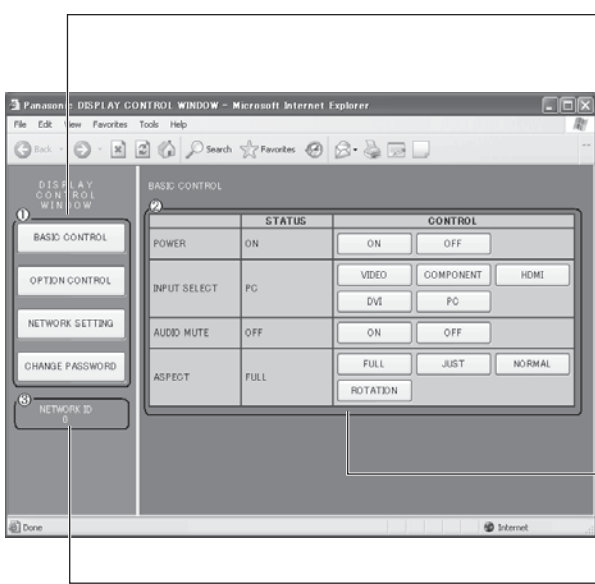

① **Menu**

Menu items are displayed. When a button is clicked, setup screen of each item is displayed.

Item	Details
BASIC CONTROL	BASIC CONTROL screen is displayed. (see below)
OPTION CONTROL	OPTION CONTROL screen is displayed. (see below)
NETWORK SETTING	Network Setup screen is displayed. (see page 69)
CHANGE PASSWORD	Password setup screen is displayed. (see page 69)

② According to the selected item from the main menu, setup status or set items are displayed.

③ **Network ID information**

ID to identify the unit is displayed.

Display Control (BASIC CONTROL/OPTION CONTROL Screen)

Click BASIC CONTROL or OPTION CONTROL from the menu. Various controls of the unit can be set.

BASIC CONTROL screen

Click BASIC CONTROL from the menu. Unit status and buttons to change settings are displayed.

	STATUS	CONTROL
POWER	ON	ON OFF
INPUT SELECT	PC	VIDEO COMPONENT HDMI DVI PC
AUDIO MUTE	OFF	ON OFF
ASPECT	FULL	FULL JUST NORMAL ROTATION

Item	Details
POWER	Switch ON/OFF of the unit power.
INPUT SELECT	Switch the input signals. Displayed buttons vary according to the connection status of the video device.
AUDIO MUTE	Switch ON/OFF of the sound mute.
ASPECT	Switch the screen modes

OPTION CONTROL screen

Click OPTION CONTROL from the menu. Command input field for command control of the unit is displayed.

COMMAND	<input type="text"/>
RESPONSE	<input type="text"/>
<input type="button" value="SEND"/>	

Item	Details
COMMAND	Enter a command. Use the same command used for the serial control. (see page 15)
RESPONSE	Response from the unit is displayed.
SEND	Command is sent and run.

Note:

After the settings are changed, it may take a while till the display status is displayed.

NETWORK SETTING (Network Setup Screen)

Click NETWORK SETTING from the menu. Various settings of a network can be set. For the details of the setting items, please check NETWORK SETUP under the SETUP of the unit. (see page 58)

DHCP	<input type="radio"/> OFF <input type="radio"/> ON
IP ADDRESS	<input type="text" value="192.168.0.8"/>
SUBNET MASK	<input type="text" value="255.255.255.0"/>
GATEWAY	<input type="text" value="192.168.0.1"/>
PORT	<input type="text" value="1024"/>
LAN SPEED	<input type="radio"/> AUTO <input type="radio"/> 10 HALF <input type="radio"/> 10 FULL <input type="radio"/> 100 HALF <input type="radio"/> 100 FULL
NETWORK ID	<input type="text" value="0"/>
<input type="button" value="SAVE"/>	

Notes:

- To use a DHCP server, make sure the DHCP server is started.
- During a DHCP server is used, IP ADDRESS, SUBNET MASK, and GATEWAY values cannot be entered.
- When the set values are changed properly, “NETWORK SETTING CHANGED.” message and the changed set items are displayed.

Item	Details
DHCP	Set to ON when a DHCP server is used, or OFF when it is not used.
IP ADDRESS	Enter an IP address.
SUBNET MASK	Enter a subnet mask.
GATEWAY	Enter a gateway address.
PORT	Enter the port number used for command control. The available setting range is 1024 - 65535.
LAN SPEED	Set the connection speed of the LAN environment.
NETWORK ID	Set the ID to identify this unit. The available setting range is 0 - 99.
SAVE	Save the each set value.

Password Setting (Password Setup Screen)

Click CHANGE PASSWORD from the menu. Password to access the Web browser control can be set. When the password is changed in this screen, the password used for command control and the PJLink™ security authentication is also changed.

OLD PASSWORD	<input type="password" value="....."/>
NEW PASSWORD	<input type="password" value="....."/>
NEW PASSWORD (RETYPE)	<input type="password" value="....."/>
<input type="button" value="SAVE"/>	











Notes:

- The default password is “Panasonic”.
- Up to 32 alphanumeric characters can be used for a password.
- When the password is changed properly, “Password has changed.” message is displayed.

Item	Details
OLD PASSWORD	Enter the old password.
NEW PASSWORD	Enter the new password.
NEW PASSWORD (RETYPE)	Enter the password entered in “NEW PASSWORD” for confirmation.
SAVE	Save the new password. The confirmation screen is displayed. Click OK to change the password.

Troubleshooting

Before you call for service, determine the symptoms and make a few simple checks as shown below.

Symptoms		Checks
Picture	Sound	
 Interference	 Noisy Sound	Electrical Appliances Cars / Motorcycles Fluorescent light
 Normal Picture	 No Sound	Volume (Check whether the mute function has been activated on the remote control.) Check if speakers are corrected properly.
 No Picture	 No Sound	Not plugged into AC outlet Not switched on PICTURE and BRIGHTNESS/Volume setting (Check by pressing the power switch or stand-by button on the remote control.)
 No Picture	 Normal Sound	If a signal with a non-applicable color system format, or frequency is input, only the input terminal indication is displayed.
 No Color	 Normal Sound	Color controls set at minimum level. (see page 29-34) COLOR SYSTEM (see page 45)
No remote control operations can be performed.		Check whether the batteries have discharged completely and, if they have not, whether they were inserted properly. Check whether the remote control sensor is exposed to an outdoor light or a strong fluorescent light. Check whether the remote control designed specifically for use with the unit is being used. (The unit cannot be operated by any other remote control.)
A cracking sound is sometimes heard from the unit.		If there is nothing wrong with the picture or sound, this is the sound of the cabinet undergoing very slight contractions in response to changes in the room temperature. There are no adverse effects on the performance or other aspects.
The top or bottom of the picture on the screen is cut off when I use the zoom function.		Adjust the position of the picture on the screen.
Areas at the top and bottom of the screen where the image is missing appear when I use the zoom function.		When using a video software program (such as a cinema size program) with a screen wider than one in the 16:9 mode, blank areas separate from the images are formed at the top and bottom of the screen.
I can hear sounds coming from inside the unit.		When the power is turned on, a sound of the display panel being driven may be heard: This is normal and not indicative of malfunctioning.
Parts of the unit become hot.		Even when the temperature of parts of the front, top and rear panels has risen, these temperature rises will not pose any problems in terms of performance or quality.
Power automatically turns off unexpectedly.		Check the settings of "PC POWER MANAGEMENT", "DVI-D POWER MANAGEMENT", "NO SIGNAL POWER OFF" and "NO ACTIVITY POWER OFF" in the SETUP menu. Any of them may be set to "ON (ENABLE)". (see page 42)
Power indicator is blinking in red.		There is possibility of malfunction. Please contact an Authorized Service Center.
This Plasma Display uses special image processing. Hence a slight time lag may occur between image and audio, depending on the type of input signal. However, this is not a malfunction.		

Plasma Display panel

Symptoms	Check
The screen darkens slightly when bright pictures with minimal movements are shown.	The screen will darken slightly when photos, still images of a computer or other pictures with minimal movements are shown for an extended period. This is done to reduce image retention on the screen and the shortening of the screen's service life: It is normal and not indicative of malfunctioning.
It takes a while for the picture to appear.	The unit digitally processes the various signals in order to reproduce esthetically pleasing images. As such, it sometimes takes a few moments for the picture to appear when the power has been turned on, when the input has been switched.
The edges of the images flicker.	Due to the characteristics of the system used to drive the panel, the edges may appear to flicker in the fast-moving parts of the images: This is normal and not indicative of malfunctioning.
The brightness on both sides of images in 4:3 mode changes.	When viewing the side panels at the "BRIGHT" or "MID" setting, the brightness on both sides may change depending on the kind of program shown: This is normal and not indicative of malfunctioning.
Some parts of the screen do not light up.	The plasma display panel is manufactured using an extremely high level of precision technology, however, sometimes some parts of the screen may be missing picture elements or have luminous spots. This is not a malfunction.
 <p>Image retention appears</p>	Do not allow a still picture to be displayed for an extended period, as this can cause a permanent image retention to remain on the Plasma Display. Examples of still pictures include logos, video games, computer images, teletext and images displayed in 4:3 mode. Note: The permanent image retention on the Plasma Display resulting from fixed image use is not an operating defect and as such is not covered by the Warranty. This product is not designed to display fixed images for extended periods of time.
Whirring sounds can be heard from the display unit.	The display unit is fitted with a cooling fan to dissipate heat generated during normal use. The whirring sound is caused by rotation of the fan and is not a malfunction.

List of Aspect Modes

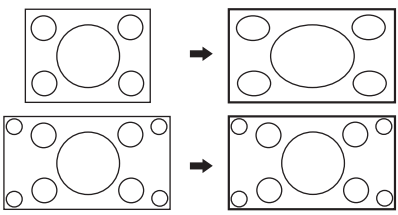
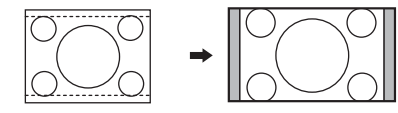
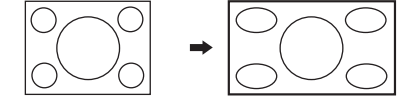
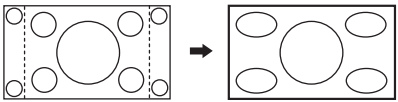
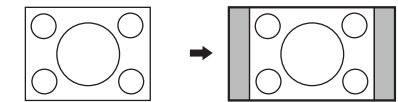
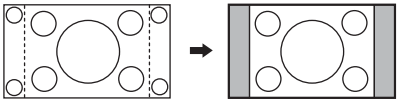
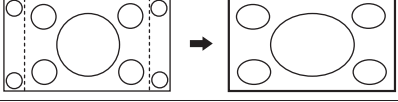
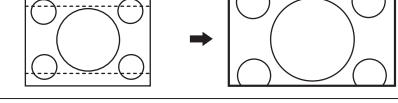
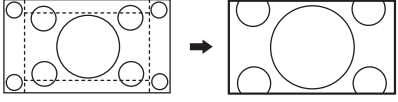
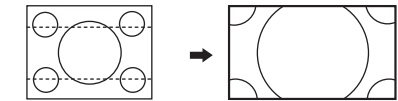
Aspect mode		Picture → Enlarged screen	Description
All Aspect: On	Factory setting All Aspect: Off		
16:9	FULL		The display of the pictures fills the screen. In the case of SD signals, pictures with a 4:3 aspect ratio are enlarged horizontally, and displayed. This mode is suited to displaying anamorphic pictures with a 16:9 aspect ratio.
14:9	–		Letterbox pictures with a 14:9 aspect ratio are enlarged vertically and horizontally so that their display fills the screen vertically and is slightly smaller than the screen horizontally. The top and bottom edges of the pictures are cut off. Side panels are displayed at the left and right edges of the screen.
Just ----- Just1	JUST		Pictures with a 4:3 aspect ratio are enlarged horizontally so that the picture distortion is minimized. The display of the areas around the left and right edges of the screen is slightly elongated.
Just2	JUST		Pictures with a 4:3 aspect ratio are enlarged horizontally so that the picture distortion is minimized. The left and right edges of the pictures are cut off. The display of the areas around the left and right edges of the screen is slightly elongated.
4:3 ----- 4:3 (1)	4:3		Pictures with a 4:3 aspect ratio are displayed with their original aspect ratio. Side panels are displayed at the left and right edges of the screen.
4:3 (2)	4:3		Pictures with a 4:3 aspect ratio are displayed with their original aspect ratio. The left and right edges of the pictures are masked by side panels.
4:3 Full	H-FILL		Pictures with a 4:3 aspect ratio are enlarged horizontally so that their display fills the screen. The left and right edges of the pictures are cut off.
Zoom ----- Zoom1	ZOOM		Letterbox pictures with a 16:9 aspect ratio are enlarged vertically and horizontally so that their display fills the screen. The top and bottom edges of the pictures are cut off.
Zoom2	ZOOM		Letterbox pictures with a 16:9 aspect ratio are enlarged vertically and horizontally so that their display fills the screen. The top and bottom edges as well as the left and right edges of the pictures are cut off.
Zoom3	–		Letterbox pictures with a 2.35:1 aspect ratio are enlarged vertically and horizontally so that their display fills the screen vertically and is slightly larger than the screen horizontally. The top and bottom edges as well as the left and right edges of the pictures are cut off.

Applicable Input Signals

*Mark: Applicable input signal

	Signal name	Horizontal frequency (kHz)	Vertical frequency (Hz)	COMPONENT / RGB IN / PC IN (Dot clock (MHz))	DVI-D IN (Dot clock (MHz))	HDMI
1	525 (480) / 60i	15.73	59.94	* (13.5)	* (27.0)	*
2	525 (480) / 60p	31.47	59.94	* (27.0) *5	* (27.0)	*
3	625 (575) / 50i	15.63	50.00	* (13.5)		
4	625 (576) / 50i	15.63	50.00		* (27.0)	*
5	625 (575) / 50p	31.25	50.00	* (27.0)		
6	625 (576) / 50p	31.25	50.00		* (27.0)	*
7	750 (720) / 60p	45.00	60.00	* (74.25)	* (74.25)	*
8	750 (720) / 50p	37.50	50.00	* (74.25)	* (74.25)	*
9	1,125 (1,080) / 60p	67.50	60.00	* (148.5) *1	* (148.5)	*
10	1,125 (1,080) / 60i	33.75	60.00	* (74.25) *1	* (74.25)	*
11	1,125 (1,080) / 50p	56.26	50.00	* (148.5) *1	* (148.5)	*
12	1,125 (1,080) / 50i	28.13	50.00	* (74.25) *1	* (74.25)	*
13	1,125 (1,080) / 24sF	27.00	48.00	* (74.25) *2		
14	1,125 (1,080) / 30p	33.75	30.00	* (74.25) *1	* (74.25)	
15	1,125 (1,080) / 25p	28.13	25.00	* (74.25) *1	* (74.25)	
16	1,125 (1,080) / 24p	27.00	24.00	* (74.25) *1	* (74.25)	*
17	1,250 (1,080) / 50i	31.25	50.00	* (74.25) *3		
18	2,048 × 1,080 / 24sF *7	27.00	48.00			
19	2,048 × 1,080 / 24p *7	27.00	24.00			
20	640 × 400 @70 Hz	31.46	70.07	* (25.17)		
21	640 × 480 @60 Hz	31.47	59.94	* (25.18) *6	* (25.18)	*
22	640 × 480 @72 Hz	37.86	72.81	* (31.5)		
23	640 × 480 @75 Hz	37.50	75.00	* (31.5)		
24	640 × 480 @85 Hz	43.27	85.01	* (36.0)		
25	800 × 600 @56 Hz	35.16	56.25	* (36.0)		
26	800 × 600 @60 Hz	37.88	60.32	* (40.0)	* (40.0)	*
27	800 × 600 @72 Hz	48.08	72.19	* (50.0)		
28	800 × 600 @75 Hz	46.88	75.00	* (49.5)		
29	800 × 600 @85 Hz	53.67	85.06	* (56.25)		
30	852 × 480 @60 Hz	31.47	59.94	* (33.54) *6	* (34.24)	*
31	1,024 × 768 @50 Hz	39.55	50.00		* (51.89)	*
32	1,024 × 768 @60 Hz	48.36	60.00	* (65.0)	* (65.0)	*
33	1,024 × 768 @70 Hz	56.48	70.07	* (75.0)		
34	1,024 × 768 @75 Hz	60.02	75.03	* (78.75)		
35	1,024 × 768 @85 Hz	68.68	85.00	* (94.5)		
36	1,066 × 600 @60 Hz	37.64	59.94	* (53.0)	* (53.0)	*
37	1,152 × 864 @60 Hz	53.70	60.00		* (81.62)	*
38	1,152 × 864 @75 Hz	67.50	75.00	* (108.0)		
39	1,280 × 768 @60 Hz	47.70	60.00	* (80.14)		
40	1,280 × 960 @60 Hz	60.00	60.00	* (108.0)		
41	1,280 × 960 @85 Hz	85.94	85.00	* (148.5)		
42	1,280 × 1,024 @60 Hz	63.98	60.02	* (108.0)	* (108.0)	*
43	1,280 × 1,024 @75 Hz	79.98	75.03	* (135.0)		
44	1,280 × 1,024 @85 Hz	91.15	85.02	* (157.5)		
45	1,366 × 768 @50 Hz	39.55	50.00		* (69.92)	*
46	1,366 × 768 @60 Hz	48.36	60.00	* (86.71)	* (87.44)	*
47	1,400 × 1,050 @60 Hz	65.22	60.00		* (122.61)	*
48	1,600 × 1,200 @60 Hz	75.00	60.00	* (162.0)	* (162.0)	*
49	1,600 × 1,200 @65 Hz	81.25	65.00	* (175.5)		
50	1,920 × 1,080 @60 Hz	67.50	60.00	* (148.5) *4	* (148.5)	*
51	1,920 × 1,200 @60 Hz	74.04	59.95		* (154.0)	*
52	Macintosh13" (640 × 480)	35.00	66.67	* (30.24)		
53	Macintosh16" (832 × 624)	49.72	74.54	* (57.28)		
54	Macintosh21" (1,152 × 870)	68.68	75.06	* (100.0)		

*1: Based on SMPTE 274M standard.

*2: Based on SMPTE RP211 standard.

*3: Based on SMPTE 295M standard.

*4: The input signal is recognized as 1,125 (1,080) / 60p.

*5: When selected the RGB format and 525p signal input to the PC IN terminal, it is recognized as VGA 60Hz signal.

*6: When inputted VGA 60Hz format signal from the other than PC IN terminal, it is recognized as 525p signal.

*7: Based on SMPTE 292M and 372M standards. These signals can be received when the Dual Link HD-SDI Terminal Board (TY-FB11DHD) or Dual HD-SDI Terminal Board for 3D (TY-FB30DHD3D) is installed.

Note: Signals without above specification may not be displayed properly.

Video input (VIDEO)

	Signal name	Horizontal frequency(kHz)	Vertical frequency(Hz)
1	NTSC	15.73	59.94
2	PAL	15.63	50.00
3	PAL60	15.73	59.94
4	SECAM	15.63	50.00
5	Modified NTSC	15.73	59.94









ID Remote Control Function

You can set the remote control ID when you want to use this remote control on one of several different displays.

Note:

To operate this function, please purchase ID remote controller sold separately.

Object model : EUR7636070R

- 1 Switch  to  on the right side.
- 2 Press the  button on the remote control.
- 3 Press one of  - ,  for the tens digit setting.
- 4 Press one of  - ,  for the units digit setting.

Notes:

- The numbers in 2, 3 and 4 should be set up quickly.
- Adjustable ID number range is 0 - 99.
- If a number button is pressed more than two times, the first two numbers become the ID number for the remote control.

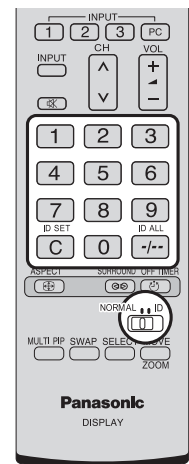

ID remote control button operation

The operation is the same as normal remote control except for the  button.

ID Cancellation

Press  button on remote control. (This has the same effect as pressing the , ,  buttons at the same time.)

Notes:

- Set the Remote ID "On" to operate the ID remote control.
If Remote ID is set to "On", you can use the remote control without identical ID number during option menu display. (see page 60)
- The ID remote control cannot be used when ID select is set to anything other than 0, and the remote control ID is not the same as the ID select number (see page 60).

Shipping condition

This function allows you to reset the unit to the factory setting.

1 Display the menu screen.



2 Select "SETUP".

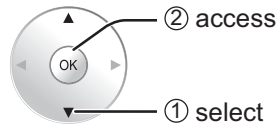
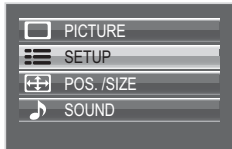

3 Select "OSD LANGUAGE".

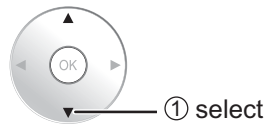
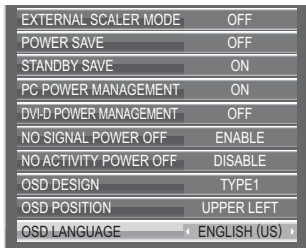

4 Press for more than 5 seconds.



5 Select "YES".

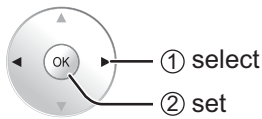
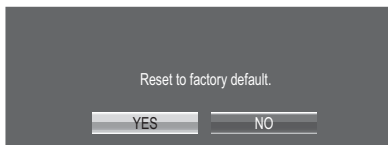

6 Select "YES" and wait for 10 sec.

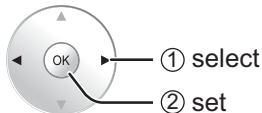
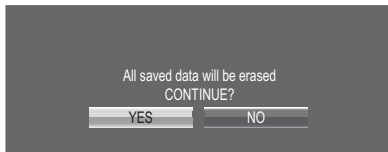

Note:

Press  to return to SETUP menu when confirmation screen is displayed.

7

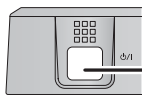

Press the power switch (⏻/⏮) on main unit to turn the power off.

[from the unit]

- 1 Press the MENU button till the SETUP menu is displayed.
- 2 Press the ▲ or ▼ button to select "OSD LANGUAGE".
- 3 Press the ENTER button for more than 5 seconds.
- 4 Press the ▲ or ▼ button to select "YES".
- 5 Press the ENTER button.
- 6 Press the ▲ or ▼ button to select "YES".
- 7 Press the ENTER button and wait for 10 sec.
- 8 Press the power switch (⏻/⏮) on main unit to turn the power off.

Executing this function restores all settings and adjustment values in the following menus to the factory-set default values, as shipped.

On-screen menu: PICTURE, ADVANCED SETTINGS, SETUP, POS. /SIZE, SOUND, OPTIONS

Specifications

	TH-42BT300U	TH-50BT300U
Power Source	110 - 127 V AC, 50/60 Hz	
Power Consumption		
Rated Power Consumption	330 W	420 W
Stand-by condition	Save OFF 0.7 W, Save ON 0.4 W	Save OFF 0.7 W, Save ON 0.4 W
Power off condition	0.2 W	0.2 W
Plasma Display panel	Drive method : AC type 42-inch, 16:9 aspect ratio	Drive method : AC type 50-inch, 16:9 aspect ratio
Screen size	36.2" (921 mm) (W) × 20.4" (518 mm) (H) × 41.6" (1,057 mm) (diagonal)	43.5" (1,105 mm) (W) × 24.4" (622 mm) (H) × 49.9" (1,268 mm) (diagonal)
(No. of pixels)	2,073,600 (1,920 (W) × 1,080 (H)) [5,760 × 1,080 dots]	
Operating condition		
Temperature	32 °F - 104 °F (0 °C - 40 °C)	
Humidity	20 % - 80 %	
Applicable signals		
Color System	NTSC, PAL, PAL60, SECAM, Modified NTSC	
Scanning format	525 (480) / 60i · 60p, 625 (575) / 50i · 50p, 750 (720) / 60p · 50p, 1125 (1080) / 60i · 60p · 50i · 50p · 24p · 25p · 30p · 24sF, 1250 (1080) / 50i	
PC signals	VGA, SVGA, XGA, SXGA UXGA (compressed) Horizontal scanning frequency 15 - 110 kHz Vertical scanning frequency 48 - 120 Hz	
Connection terminals		
LAN	RJ45 10BASE-T/100BASE-TX, compatible with PLink™	
AV IN	VIDEO AUDIO L-R	BNC 1.0 Vp-p (75 Ω) RCA Pin jack × 2 0.5 Vrms
	HDMI	TYPE A Connector
COMPONENT/RGB IN	Y/G P _B /C _B /B P _R /C _R /R AUDIO L-R	BNC with sync 1.0 Vp-p (75 Ω) BNC 0.7 Vp-p (75 Ω) BNC 0.7 Vp-p (75 Ω) RCA Pin jack × 2 0.5 Vrms
DVI-D IN	AUDIO	DVI-D 24 Pin Content Protection Stereo mini jack (M3) × 1 0.5 Vrms, Shared with PC IN
PC IN	AUDIO	High-Density Mini D-sub 15 Pin Y or G with sync 1.0 Vp-p (75 Ω) Y or G without sync 0.7 Vp-p (75 Ω) P _B /C _B /B: 0.7 Vp-p (75 Ω) P _R /C _R /R: 0.7 Vp-p (75 Ω) HD/VD: 1.0 - 5.0 Vp-p (high impedance) 0.5 Vrms, Shared with DVI-D IN
SERIAL		External Control Terminal D-sub 9 Pin RS-232C compatible
3D IR TRANSMITTER		for 3D IR TRANSMITTER
3D SHUTTER OUT DC 8V OUT		M3 jack × 1 Center plus, for EIAJ 4mm plug
EXT SP	Speaker Terminal	6 Ω, 16 W [8 W + 8 W] (10 % THD)
Dimensions (W × H × D)	40.2" (1,020 mm) × 24.1" (610 mm) × 3.5" (89 mm)	47.7" (1,210 mm) × 28.5" (724 mm) × 3.5" (89 mm)
Mass (weight)		
main unit only	approx. 57.4 lbs	approx. 75.0 lbs
with speakers	approx. 68.4 lbs	approx. 86.0 lbs

Note:

Design and specifications are subject to change without notice. Mass and dimensions shown are approximate.

<Software Information for This Product>

This product has software installed partially licensed under the Free BSD LICENSE. Free BSD LICENSE regulations under the above specifications are as follows: (These regulations are set by the third party; therefore the original (English) regulations are stated.)

Copyright © 1980, 1986, 1993
The Regents of the University of California. All rights reserved.

Redistribution and use in source and binary forms, with or without modification, are permitted provided that the following conditions are met:

1. Redistributions of source code must retain the above copyright notice, this list of conditions and the following disclaimer.
2. Redistributions in binary form must reproduce the above copyright notice, this list of conditions and the following disclaimer in the documentation and/or other materials provided with the distribution.
3. All advertising materials mentioning features or use of this software must display the following acknowledgement: This product includes software developed by the University of California, Berkeley and its contributors.
4. Neither the name of the University nor the names of its contributors may be used to endorse or promote products derived from this software without specific prior written permission.

THIS SOFTWARE IS PROVIDED BY THE REGENTS AND CONTRIBUTORS "AS IS" AND ANY EXPRESS OR IMPLIED WARRANTIES, INCLUDING, BUT NOT LIMITED TO, THE IMPLIED WARRANTIES OF MERCHANTABILITY AND FITNESS FOR A PARTICULAR PURPOSE ARE DISCLAIMED. IN NO EVENT SHALL THE REGENTS OR CONTRIBUTORS BE LIABLE FOR ANY DIRECT, INDIRECT, INCIDENTAL, SPECIAL, EXEMPLARY, OR CONSEQUENTIAL DAMAGES (INCLUDING, BUT NOT LIMITED TO, PROCUREMENT OF SUBSTITUTE GOODS OR SERVICES; LOSS OF USE, DATA, OR PROFITS; OR BUSINESS INTERRUPTION) HOWEVER CAUSED AND ON ANY THEORY OF LIABILITY, WHETHER IN CONTRACT, STRICT LIABILITY, OR TORT (INCLUDING NEGLIGENCE OR OTHERWISE) ARISING IN ANY WAY OUT OF THE USE OF THIS SOFTWARE, EVEN IF ADVISED OF THE POSSIBILITY OF SUCH DAMAGE.

USA Only:

Disposal may be regulated in your community due to environmental considerations. For disposal or recycling information, please visit Panasonic website:
<http://www.panasonic.com/environmental> or call 1-888-769-0149.

Customer's Record

The model number and serial number of this product can be found on its back cover. You should note this serial number in the space provided below and retain this book, plus your purchase receipt, as a permanent record of your purchase to aid in identification in the event of theft or loss, and for Warranty Service purposes.

Model Number _____

Serial Number _____

© Panasonic Corporation 2011

Panasonic Solutions Company

Unit of Panasonic Corporation of North America

Executive Office :

Three Panasonic Way 2F-5, Secaucus, NJ 07094

Panasonic Canada Inc.

5770 Ambler Drive
Mississauga, Ontario
L4W 2T3