

artsound

Operating Manual

MX-240S

MIXER ZONE AMPLIFIER

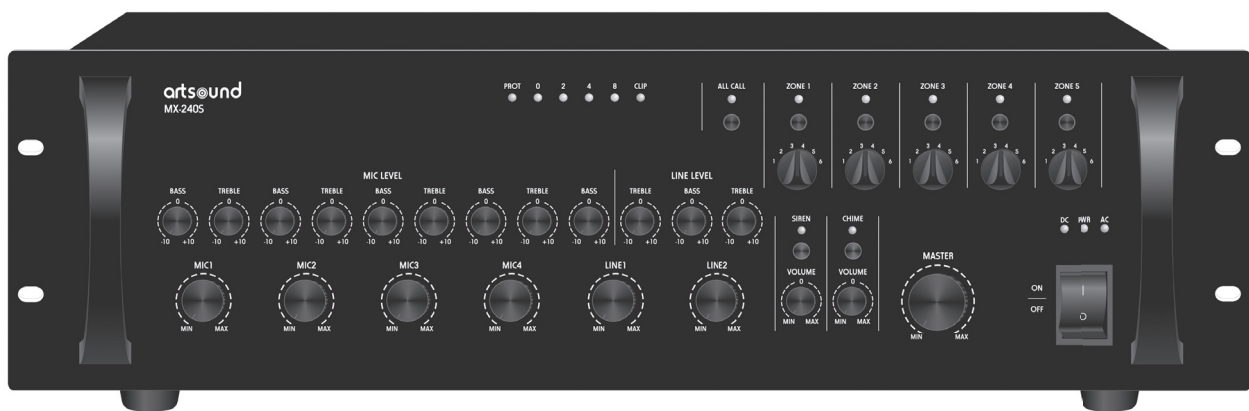

Please follow the instructions in this manual to obtain the optimum results from this unit.
We also recommend that you keep this manual handy for future reference

Check our website for any updates of this manual: www.artsound.be

House of Music nv
Ronse, Belgium
www.artsound.be
Tel. +32 9 380 81 80
Fax. +32 9 386 12 35
info@artsound.be

Table of contents

1. Safety precautions	3
2. General description	4
3. Features	4
4. Nomenclature and functions	5
4.1 front panel	5
4.2 rear panel	6
5. Connections	7
6. Applications	8
7. Specifications	9
8. Block diagram	10
9. Dimensional diagram	11

1 Safety precautions.

- Be sure to read the instructions in this section carefully before use.
- Make sure to observe the instructions in this manual as the conventions of safety symbols and messages regarded as very important precautions are included.
- We also recommend you keep this instruction manual handy for future reference.

Warnings and safety.

Safety Symbol and Message Conventions.

Safety symbols and messages described below are used in this manual to prevent bodily injury and property damage, which could result from mishandling. Before operating your product, read this manual first and understand the safety symbols and messages so you are thoroughly aware of the potential safety risk.



WARNING

Indicates a potentially hazardous situation which, if mishandled, could result in death or serious personal injury.



CAUTION

Indicates a potentially hazardous situation which, if mishandled, could result in moderate or minor personal injury, and/or property damage.

Warning.

When Installing the Unit.

- Do not expose the unit to rain or an environment where it may be splashed by water or other liquids, as doing so may result in fire or electric shock.
- Use the unit only with the voltage specified on the unit. Using a voltage higher than that which is specified may result in fire or electric shock.
- Do not cut, kink, otherwise damage nor modify the power supply cord. In addition, avoid using the power cord in close proximity to heaters, and never place heavy objects -- including the unit itself -- on the power cord, as doing so may result in fire or electric shock.
- Be sure to replace the unit's terminal cover after connection completion. Because high voltage is applied to the speaker terminals, never touch these terminals to avoid electric shock.
- Be sure to ground to the safety ground (earth) terminal to avoid electric shock. Never ground to a gas pipe as a catastrophic disaster may result.
- Avoid installing or mounting the unit in unstable locations, such as on a rickety table or a slanted surface. Doing so may result in the unit falling down, causing personal injury and/or property damage.

When the Unit is in Use.

- Should the following irregularity be found during use, immediately switch off the power, disconnect the power supply plug from the AC outlet and contact your nearest ArtSound dealer. Make no further attempt to operate the unit in this condition as this may cause fire or electric shock.
 - If you detect smoke or a strange smell coming from the unit.
 - If water or any metallic object gets into the unit
 - If the unit falls, or the unit case breaks
 - If the power supply cord is damaged (exposure of the core, disconnection, etc.)
 - If it is malfunctioning (no tone sounds.)
- To prevent a fire or electric shock, never open nor remove the unit case as there are high voltage components inside the unit. Refer all servicing to your nearest ArtSound dealer.
- Do not place cups, bowls, or other containers of liquid or metallic objects on top of the unit. If they accidentally spill into the unit, this may cause a fire or electric shock.
- Do not insert nor drop metallic objects or flammable materials in the ventilation slots of the unit's cover, as this may result in fire or electric shock.

Caution.

When Installing the Unit.

- Never plug in nor remove the power supply plug with wet hands, as doing so may cause electric shock.
- When unplugging the power supply cord, be sure to grasp the power supply plug; never pull on the cord itself. Operating the unit with a damaged power supply cord may cause a fire or electric shock.
- When moving the unit, be sure to remove its power supply cord from the wall outlet. Moving the unit with the power cord connected to the outlet may cause damage to the power cord, resulting in fire or electric shock. When removing the power cord, be sure to hold its plug to pull.
- Do not block the ventilation slots in the unit's cover. Doing so may cause heat to build up inside the unit and result in fire.
- Avoid installing the unit in humid or dusty locations, in locations exposed to the direct sunlight, near the heaters, or in locations generating sooty smoke or steam as doing otherwise may result in fire or electric shock.

When the Unit is in Use.

- Do not place heavy objects on the unit as this may cause it to fall or break which may result in personal injury and/or property damage. In addition, the object itself may fall off and cause injury and/or damage.
- Make sure that the volume control is set to minimum position before power is switched on.
- Loud noise produced at high volume when power is switched on can impair hearing.
- Do not operate the unit for an extended period of time with the sound distorting. This is an indication of a malfunction, which in turn can cause heat to generate and result in a fire.
- Contact your ArtSound dealer as to the cleaning. If dust is allowed to accumulate in the unit over a long period of time, a fire or damage to the unit may result.
- If dust accumulates on the power supply plug or in the wall AC outlet, a fire may result. Clean it periodically. In addition, insert the plug in the wall outlet securely.
- Switch off the power, and unplug the power supply plug from the AC outlet for safety purposes when cleaning or leaving the unit unused for 10 days or more. Doing otherwise may cause a fire or electric shock.

An all-pole mains switch with a contact separation of at least 3 mm in each pole shall be incorporated in the electrical installation of the building.

Due to product upgrades, while some of the features and specification in the user manual does not match the actual functions, sorry for any inconvenience and thanks for your kind understanding!

2. General description.

The Mixer Zone Amplifier series is equipped with priority function. They are designed to suit all PA system application in schools home offices and stores.

3. Features

- 5 zone output and 5 zone separate volume control
- Built-in siren
- Built-in 24V interface
- Each channel with separate treble and bass control
- Built-in 24V phantom power and separate power switch
- Capacity of controlling by remote paging MIC
- Selectable priority muting.
- Switchable audio signal priority for MIC channels 1.
 - 1 EMC input signal over other input sources, all 100V-open the area.
 - 2 Remote MIC and Telephone input over SIREN, CHIME, MIC 1~4, LINE 1~2, input sources.
 - 3 MIC 1 SIREN CHIME over MIC 2~3, LINE 1~2 input sources.

4. Nomenclature and functions.

4.1 Front panel

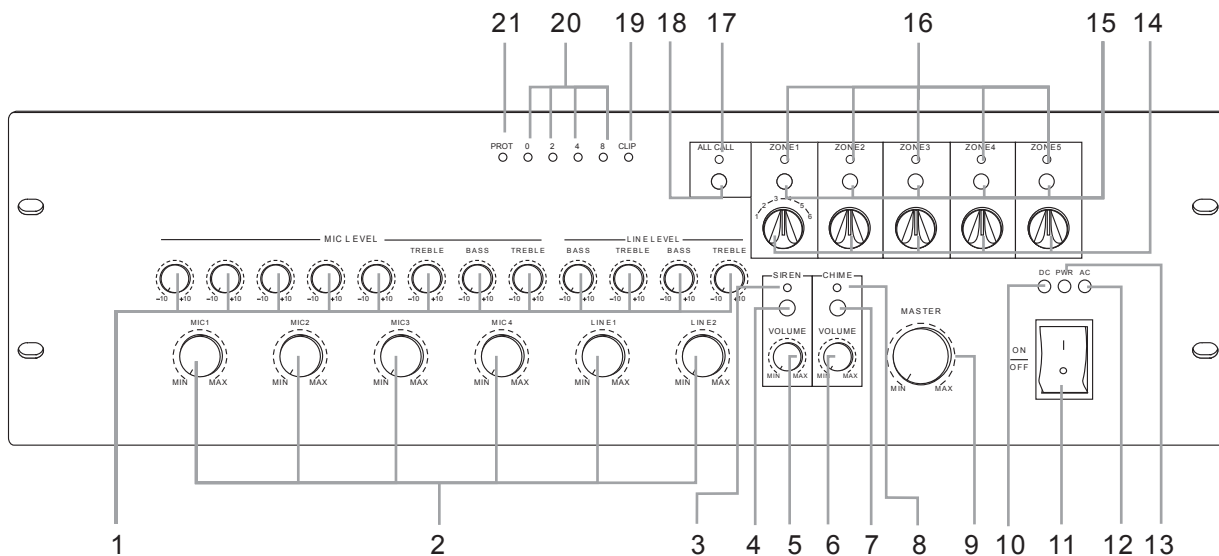

1. TONE CONTROL

Individual Bass and Treble controls are used to cut(decrease) or boost(increase) the lower and higher frequencies +12dB.

2. CHANNEL VOLUME

Controls the individual volume levels of Channels.

3. ALARM INDICATOR

4. ALARM BUTTON

Press the bell button bell light, a bell indicating the input signal output; bell signal conditioning potentiometer can adjust its output volume.

5. ALARM POTENTIOMETER

6. BELL SIGNAL POTENTIOMETER

7. BELL SIGNAL BUTTON

Press the alarm button, alarm light, alarm indication signal input with the output; alarm signal conditioning potentiometer can adjust the output volume

8. BELL SIGNAL INDICATOR

9. MASTER VOLUME

This rotary switch controls the overall output volume of the amplifiers output signal.

10. DC INDICATOR

24V DC supply power the indicator on

11. POWER SWITCH

Pressing this switch turns the unit on, as indicated by the Power LED above the swh. Pressing it again turns the unit off.

12. AC INDICATOR

~230V AC supply power the indicator on

13. POWER SWITCH INDICATOR

14. SPEAKER SELECTOR

These switches are used to select output to any combination of up to five individual speakers.

OUTPUT VOLTAGE		MIN	2
	120 W	6 V	12,5 V
	240 W	6 V	12,5 V
120W	350 W	6 V	12,5 V
3	4	5	MAX
22 V	50 V	70 V	100 V
32 V	50 V	70 V	100 V
38 V	50 V	70 V	100 V

15. (ZONE 1~ZONE 5) ZONE SELECTION BUTTON

16. (ZONE 1~ZONE 5) ZONE SELECTION INDICATOR

17. ALL CALL INDICATOR

18. ALL CALL CONTROL

19. CLIP INDICATOR LED

20. OUTPUT LEVEL INDICATOR LED

21. PROTECT INDICATOR LED

4.2 Rear panel

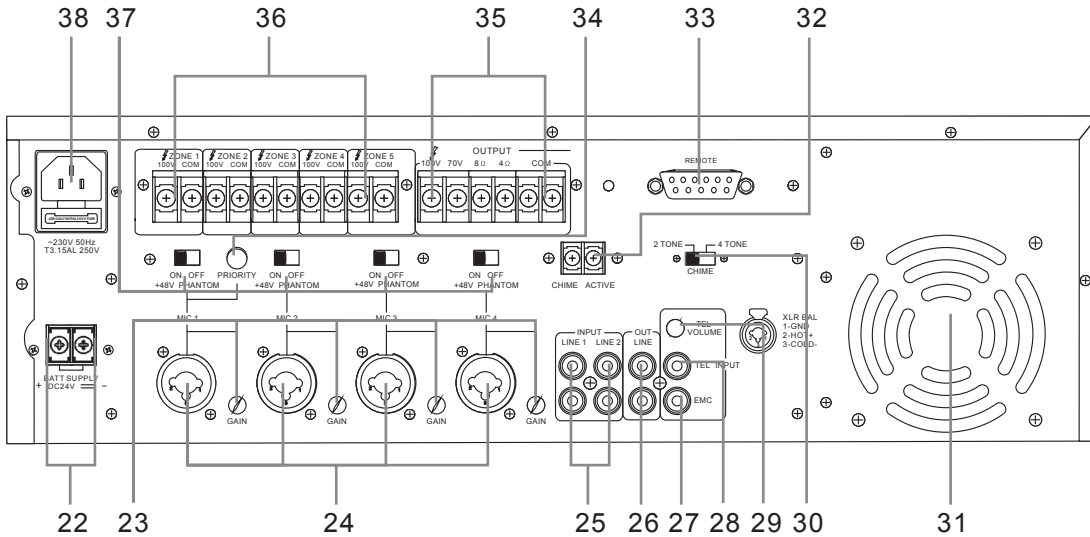

22. DC INPUT TERMINALS

These terminals are provided for the connection of backup battery. Connect a 24VDC 50A battery source to these terminals. Make certain the red terminal is connected to the battery's positive (+) side, and the black terminal to the battery's negative (-) side.

23. INPUT GAIN CONTROLS (TRIM VR)

These knobs provide continuous control of the input levels for each of the six input channels. When adjusting the input gain, make certain that the levels are not set too high, or distortion will result.

NOTE: It is safe to connect most modern dynamic microphones or line level devices to the channel Inputs when phantom power is activated. However, some older ribbon microphones may be damaged by phantom power, and certain unbalanced line level devices may malfunction or produce an audible hum when phantom power is active.

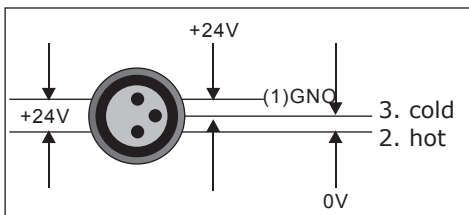

24. MIC INPUT CHANNEL 1~4

This is a special connector which will accept either a 3-conductor XLR or a 3-conductor 1/3 jack. These inputs are suitable to receive signal from microphones level devices.

MIC JACK (XLR JACK)	LINE JACK (TRS PHONE JACK)
Pin 1: GROUND	Sleeve: GROUND
Pin 2: HOT(+)	Tip: HOT(+)
Pin 3: COLD(-)	Ring: COLD(-)

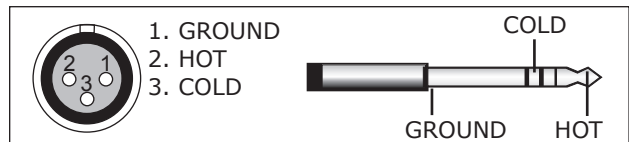

25. LINE INPUT CHANNEL 1~2

This line-level input is an extra stereo input for a stereo source such as a tape deck or CD player.

26. LINE OUTPUT

(Connection for power amplifier or recording equipment)

27. EMC INPUT

When EM switch is connected and pressed in fire or other emergencies, EM broadcasting stored in voice ic is outputted. When selected, these switches will give priority to over all other signals inputs.

28. TEL AUDIO INPUT

Remote telephone paging and announcement

29. TEL AUDIO VOLUME

30. CHIME

2 Tone/4 Tone chime sw

31. FANNER

32. CHIME ACTIVE

Automatic or manual activate chime when paging

33. REMOTE CONTROL INPUT

By connecting a 15-pin D-SUB connector, it is possible to control speaker zone selection and activate the chime via wired remote. Connection terminals for the remote are shown below.

- Pin 1: Remote amplifier input signal hot(+)
- Pin 2: Remote amplifier input signal cold(-)
- Pin 3: Signal ground
- Pin 4: Remote control 1 (Speaker 1)
- Pin 5: Remote control 2 (Speaker 2)
- Pin 6: Remote control 3 (Speaker 3)
- Pin 7: Remote control 4 (Speaker 4)
- Pin 8: Remote control 5 (Speaker 5)
- Pin 9: Remote control ground
- Pin 10: DC +24 V
- Pin 11: Input Chime
- Pin 12: NC
- Pin 13: NC
- Pin 14, 15: NC

34. MIC 1 PRIORITY SWITCH

When selected, these switches will give priority to channels 1 over all other channels inputs.

35. 4 ohms\8 ohms 70 V \ 100 V SPEAKER OUTPUT TERMINAL

This terminal is for speaker wire connection. Connect speakers whose combined impedance is equal to or higher than the rated output impedance, as shown below.

36. (CH1~CH5) ZONE SPEAKER OUTPUT

37. POWER SWITCH

This switch turns the phantom power supply on or off for all channels. When the switch is turned on, +24V DC power is supplied to pins 2 and 3 of each channel's input connector. Use phantom power when connecting condenser microphones, which require an external power supply.

38. ~220-240 V 50 / 60 HZ POWER INPUT

5. Connections.

Speaker connections

Before connecting speakers, disconnect the AC power cable. Note the proper connecting terminals as shown below. Make certain that the total impedance is not less than the rated impedance indicated.

CONNECTING HIGH-VOLTAGE DISTRIBUTED SPEAKER SYSTEMS

When connecting speaker system in parallel, you can connect of up to 100W.

Note:

- Be sure that total impedance is not less than rated impedance. (See upper chart.)

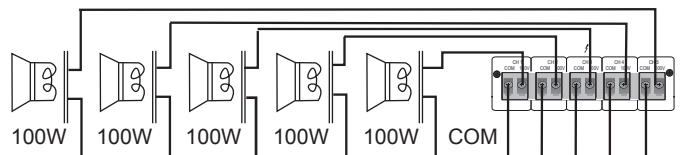

WARNING

Extreme care must be exercised when connecting high-impedance systems, as Potentially Hazardous voltages may be present at these terminals.

Do not install this equipment in a confined space with less-than-adequate ventilation.

6. Applications.

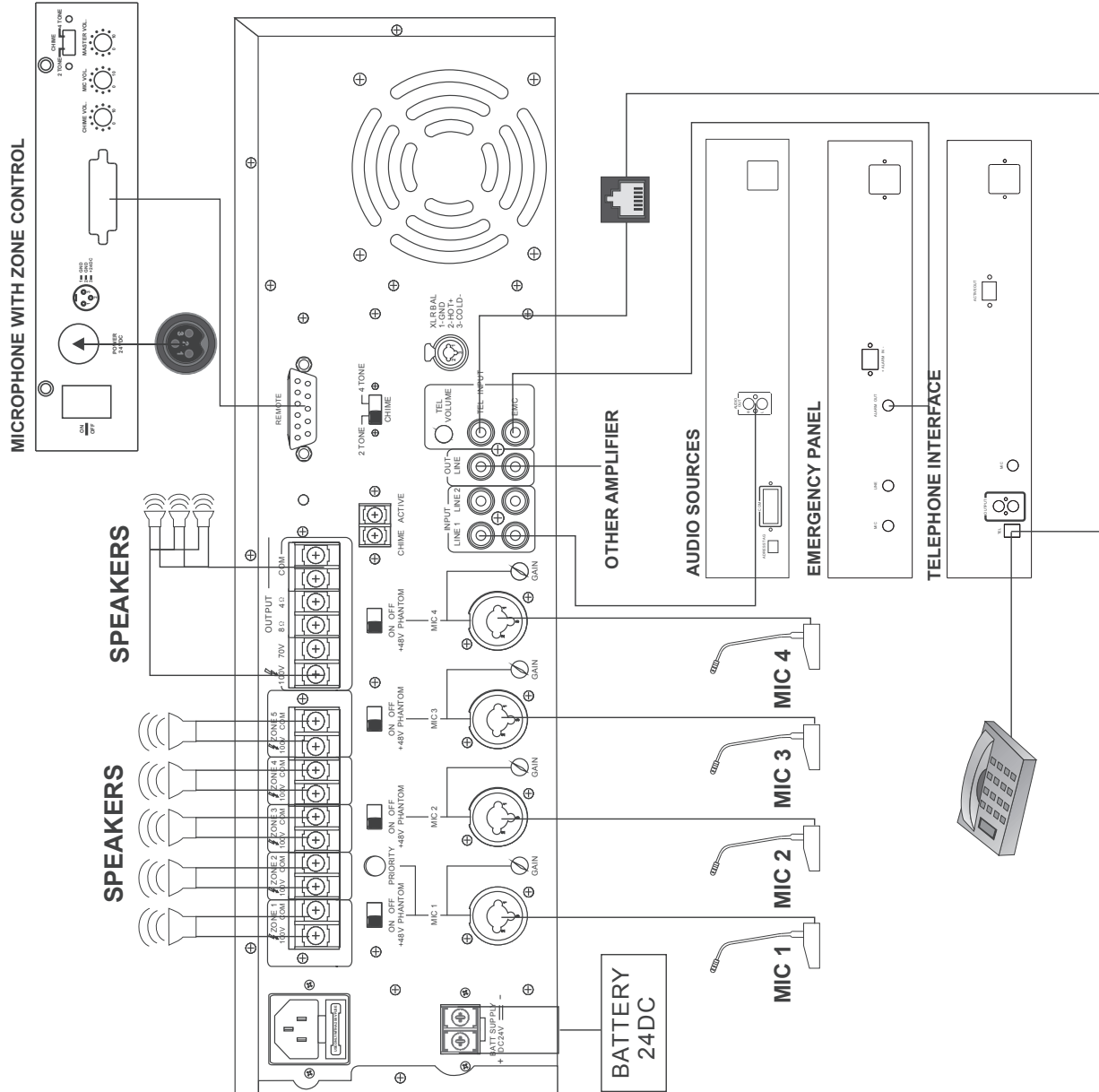

7. Specifications.

Amplifier section 4 Ohms load output	Rated output power (THD 1%)	240 W (RMS)
	Speaker zone 1~5 output 25 W	50 W MAX
Line Input section (Line 1~2 in @ 1 KHz,)	Input sensitivity/impedance	2.45 MV / 5 K Ω BAL/245 MV / 5 Kohm BAL
	S/N	Better than 55 dB
	Frequency response (3 dB)	100 Hz ~ 15 KHz
	Tone control (bass:100hz, Treble:10 KHz	+/- 12 dB
	Phantom power	+ 24 V DC
Line input section (Line1~2 in@1 KHz,)	Input sensitivity/impedance	250 mV / 47 Kohm
	S/N	Better than 65 dB
	Frequency response (3db)	80 Hz ~ 15 KHz
	Tone control (bass:100 Hz, treble:10 KHz	+/- 12 dB
Tel audio input	Input sensitivity/impedance	250 mV / 47 Kohm
	S/N	Better than 65 dB
	Frequency response (3 dB)	80 Hz ~ 15 KHz
Pre amp out (MIC 1~4, line 1~2, TEL in, remote IN)		+/- 12 dB
Remote MIC		30 m V / 600 Ω
T.H.D		Less than 0.5 %
Power source		~220-240 V ; 50/60 Hz , 24 VDC
Power consumption		350 W
Weight		20.4 kg
Dimensions (mm)		484 x 450 x 132

8. Block diagram.

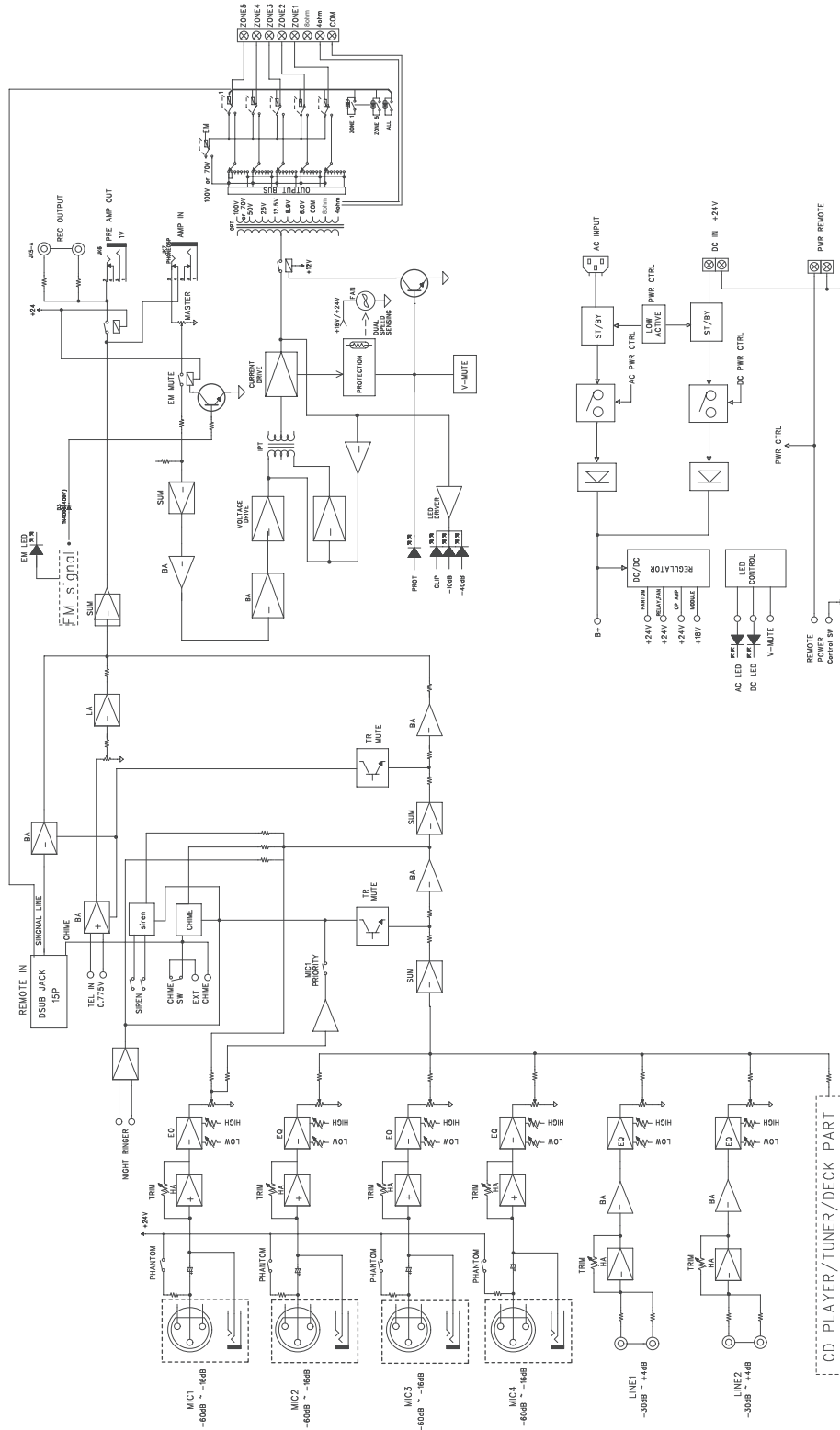

9. Dimensional diagram.

UNIT : mm

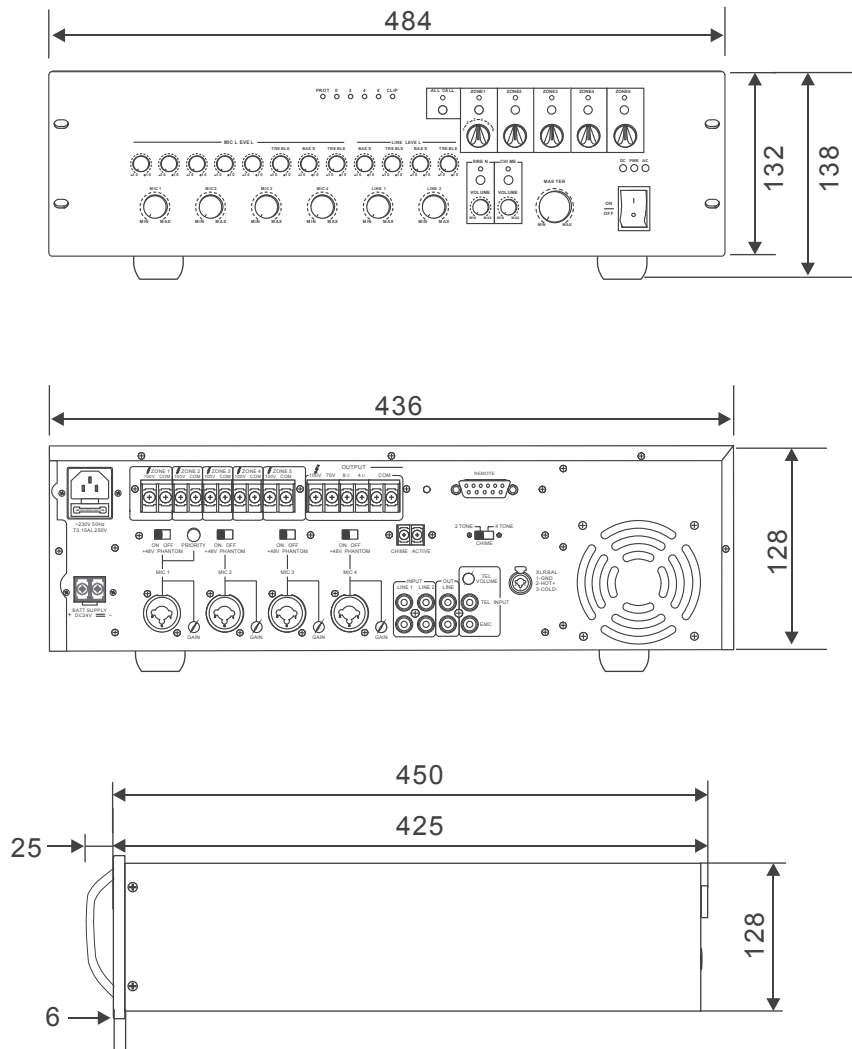

Keep the unit's all sides over 10 cm away from objects that may obstruct air flow to prevent the unit's internal temperature rise.

UNIT : mm

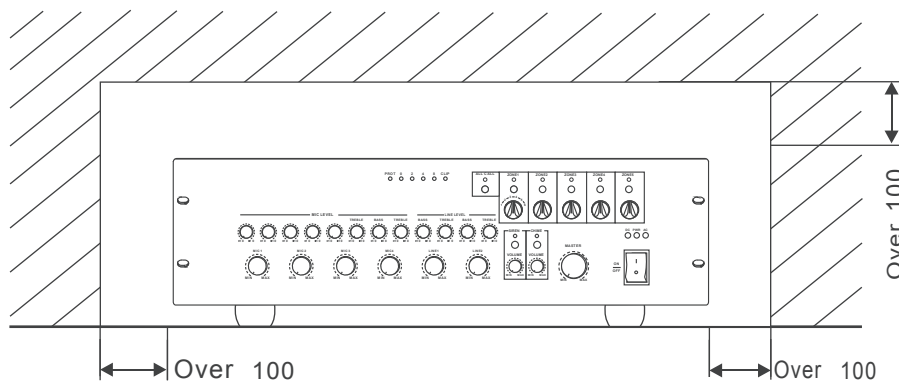

artsound

smart solutions in audio



**Discover the complete ArtSound
range at www.artsound.be**

House Of Music NV
Ronse, Belgium
www.artsound.be
Tel. +32 9 380 81 80
Fax. +32 9 386 12 35
info@artsound.be